

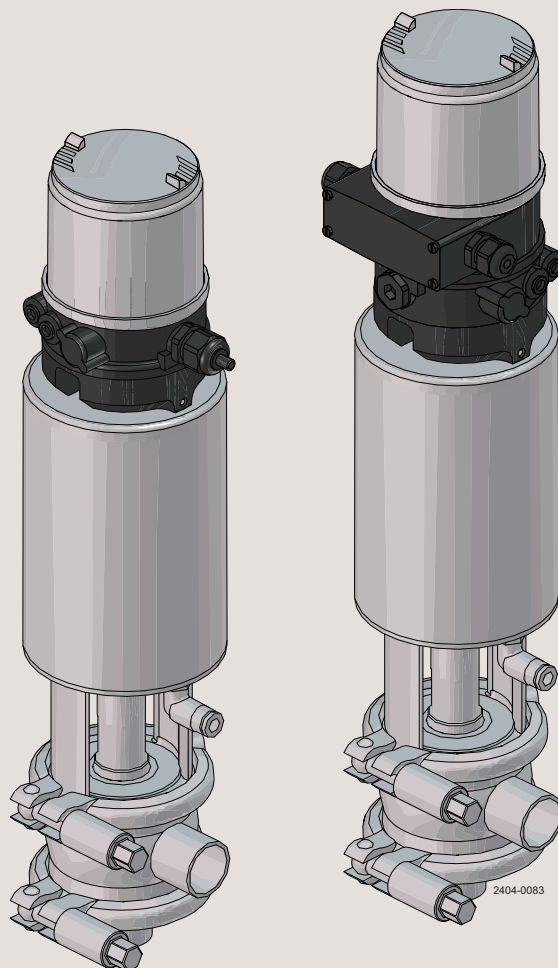

Spare Parts

Unique RV-ST Regulating Valve



ESE02161-EN10

2022-09

Original manual

The information herein is correct at the time of issue but may be subject to change without prior notice

1. Important information	4
2. Unique RV-ST Regulating Valve (sizes 25mm-51 mm/DN25-DN50)	6
3. Unique RV-ST Regulating Valve (sizes 63.5 mm-101.6 mm/DN65-DN100)	14
4. Maintainable actuator (sizes 25mm-51 mm/DN25-DN50)	20
5. Maintainable actuator (sizes 63.5 mm-101.6 mm/DN65-DN100)	22



1 Important information

Different actuator types for the SSV valve

In June 2016 the below change was implemented and the "removable yoke with bolts" version is thereby phased out and replaced by the "yoke without bolts" version.

NOTE

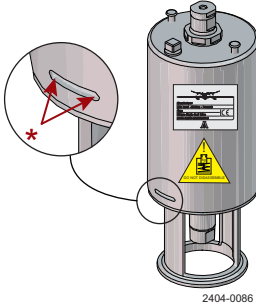
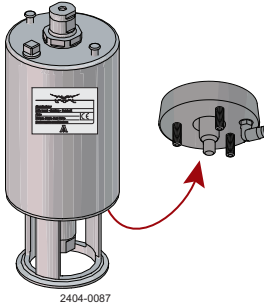
It is important to check for warnings marked on the actuator when servicing an actuator- see below table.

<p>Actuator type</p>	<p>Non-maintable actuator Spring under load and can NOT be opened</p>  <p>*) Lock wire opening is locked, when warning is marked on actuator</p>	<p>Fully maintainable actuator Spring cage and can be opened</p> 	<p>Fully maintainable actuator Spring cage and can be opened</p> 
<p>Yoke type</p>	<p>Non-removable yoke</p>	<p>"Removable yoke with bolts". If the yoke with bolts is damaged it has to be replaced by the "yoke without bolts"</p>	<p>"Yoke without bolts"</p>
<p>Service</p>	<p>Not possible to service internally (it is not possible to change piston o-rings)</p>	<p>Yes</p>	<p>Yes</p>
<p>Marked with warnings</p>	<p>Yes</p>	<p>No</p>	<p>No</p>
<p>Year of production</p>	<p>From 2006</p>	<p>From 2006 - June 2016</p>	<p>From June 2016</p>

Unique RV-ST Regulating Valve (sizes 25mm-51 mm/DN25-DN50)

If the actuator is marked with a danger warning do **NOT** attempt to cut the actuator open.



Do **NOT** attempt to disassemble the actuator due to spring under load danger!

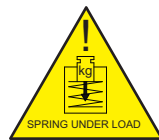

Do **NOT** attempt to cut the actuator open, due to spring under load danger!

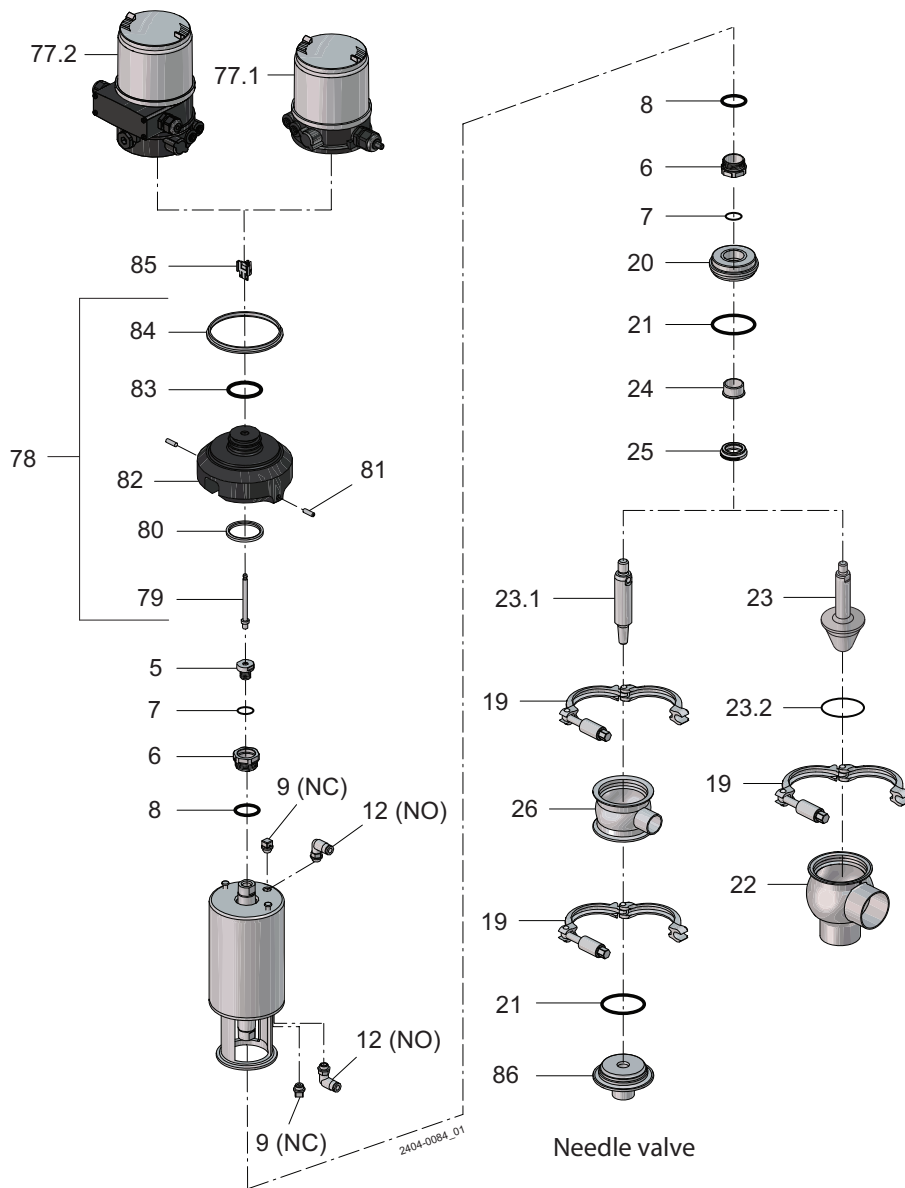

Unique RV-ST Regulating Valve (sizes 25mm-51mm/DN25-DN50)

Pos	Qty	Denomination	25 mm DN25 Needle	25 mm DN25 Standard	DN40 38 mm	DN50 51 mm
Actuator						
		Actuator, complete (NO)	9613154801	9613154801	9613154801	9613154802
		Actuator, complete (NC)	9613154806	9613154806	9613154806	9613154807
		Actuator, complete (A/A)				
		Actuator, complete (NO) - US	9613154846	9613154846	9613154846	9613154847
		Actuator, complete (NC) - US	9613154851	9613154851	9613154851	9613154852
		Actuator, complete (A/A) - US				
6	□ 2	Bushing				
7	□ 2	O-ring				
8	□ 2	O-ring				
9	1	Plug	9613414101	9613414101	9613414101	9613414101
12	1	Air fitting	9611991988	9611991988	9611991988	9611991988
	1	Air fitting - US	9611994682	9611994682	9611994682	9611994682
76	1	Positioner, 8694, (incl. pos. 77 to 85) - without display	9611995266	9611995266	9611995266	9611995266
	1	Positioner, 8692, (incl. pos. 77 to 85) - with display	9611995268	9611995268	9611995268	9611995268
	1	Positioner, 8694, (incl. pos. 77 to 85) - US - without display	9634085943	9634085943	9634085943	9634085943
	1	Positioner, 8692, (incl. pos. 77 to 85) - US - with display	9634085944	9634085944	9634085944	9634085944
77.1	1	Positioner, 8694, without display				
	1	Positioner, 8692, with display				
77.2	1	Positioner - US, 8694, without display				
	1	Positioner - US, 8692 with display				
78	1	Adapter, cpl. (incl. pos. 79 to 84)	9611995337	9611995337	9611995337	9611995337
79	1	Spindle				
80	1	Special X-ring	9612569601	9612569601	9612569601	9612569601
81	2	Allen screw	9611993409	9611993409	9611993409	9611993409
82	1	Adapter				
83	1	O-ring	9611995273	9611995273	9611995273	9611995273
84	1	Gasket for adapter	9611995274	9611995274	9611995274	9611995274
85	1	Puck sensorpad, cpl.	9611995275	9611995275	9611995275	9611995275
Clamp						
19	2	Clamp	9612939303			
	1	Clamp		9612939303	9612939303	9612939304
Bonnet						
20	1	Bonnet	9613127102	9613127102	9613127102	9613127103
21	♦ 2	O-ring, EPDM (standard)				
	♦ 2	O-ring, HNBR				
	♦ 2	O-ring, FPM				
	♦ 1	O-ring, EPDM (standard)				
	♦ 1	O-ring, HNBR				
	♦ 1	O-ring, FPM				
		O-ring, set (10 pcs.), EPDM	9614059422	9614059422	9614059422	9614059425
		O-ring, set (10 pcs.), HNBR	9614059423	9614059423	9614059423	9614059426
		O-ring, set (10 pcs.), FPM	9614059424	9614059424	9614059424	9614059427
24	1	Bushing	9613125002	9613125002	9613125002	9613125002
25	♦ 1	Lip seal, EPDM (standard)				
	♦ 1	Lip seal, HNBR				
	♦ 1	Lip seal, FPM				
		Lip seal, set (10 pcs.) EPDM	9614059419	9614059419	9614059419	9614059419
		Lip seal, set (10 pcs.) HNBR	9614059420	9614059420	9614059420	9614059420
		Lip seal, set (10 pcs.) FPM	9614059421	9614059421	9614059421	9614059421
Valve body						
22	1	Valve body, lower, 2 ports ISO		9613139501	9613139503	9613139505
	1	Valve body, lower, 3 ports ISO		9613139502	9613139504	9613139506
	1	Valve body, lower, 2 ports DIN		9613139601	9613139603	9613139605
	1	Valve body, lower, 3 ports DIN		9613139602	9613139604	9613139606
	1	Valve body, lower, 2 ports, clamp - US		9613161617	9613161631	9613161645
	1	Valve body, lower, 3 ports, clamp - US		9613161626	9613161640	9613161654
26	1	Valve body, upper, 1 port ISO, welding ends	9613139301			
	1	Valve body, upper, 2 ports ISO, welding ends	9613139302			
	1	Valve body, upper, 1 port DIN, welding ends	9613139401			
	1	Valve body, upper, 2 ports DIN, welding ends	9613139402			
	1	Valve body, upper, 1 port, clamp ends - US	9613161513			
	1	Valve body, upper, 2 ports, clamp ends - US	9613161516			
86	1	Valve body base, welding end, ISO	8010009122			
	1	Valve body base, welding end, DN	8010009123			
	1	Valve body base, clamp - ISO	8010013384			
	1	Valve body base, clamp - DIN	8010013405			
	1	Valve body base, male part SMS	8010013698			
	1	Valve body base, male part DIN	8010013894			
	1	Valve body base, clamp - US	9634087702			

Unique RV-ST Regulating Valve (sizes 25mm-51 mm/DN25-DN50)

If the actuator is marked with a danger warning do **NOT** attempt to cut the actuator open.

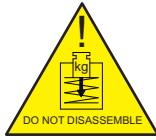

Do **NOT** attempt to disassemble the actuator due to spring under load danger!

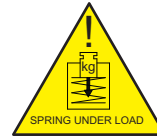

Do **NOT** attempt to cut the actuator open, due to spring under load danger!

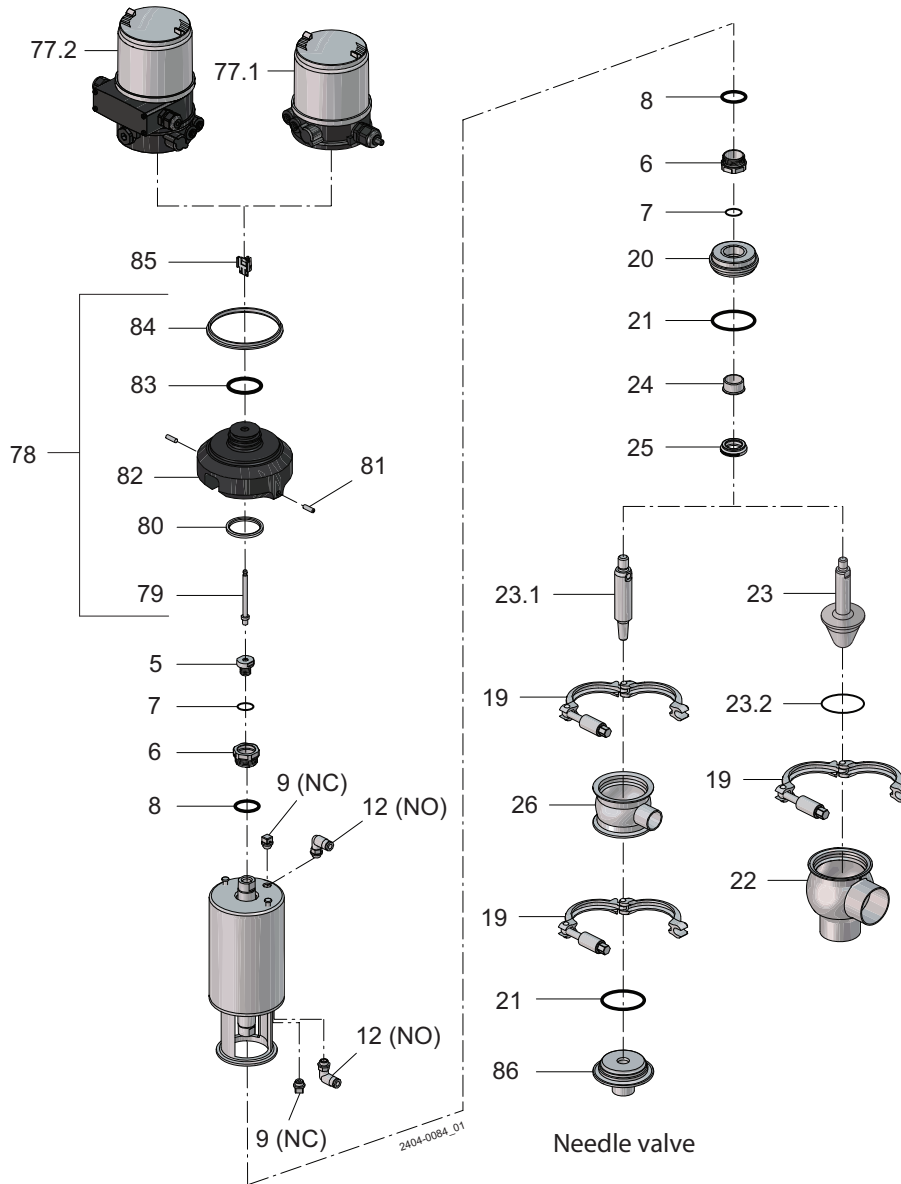

Unique RV-ST Regulating Valve (sizes 25mm-51mm/DN25-DN50)

Pos	Qty	Denomination	25 mm DN25 Needle	25 mm DN25 Standard	DN40 38 mm	DN50 51 mm
Needle						
23	1	Needle, Kv 1	9634087802			
	1	Needle, Kv 1.5	9634087803			
	1	Needle, Kv 1.9	9634087804			
	1	Needle, Kv 2.5	9634087805			
	1	Needle, Kv 2.9	9634087806			
	1	Needle, Kv 6.7 - ISO		9634087901		
	1	Needle, Kv 6.7 - DIN		8010017423		
	1	Needle, Kv 13		9634088001		
Plug, complete, ISO, EPDM (standard)						
	1	Plug, Kv 4			8010000842	
	1	Plug, Kv 6			8010000843	
	1	Plug, Kv 10			8010000844	
	1	Plug, Kv 14			9613158901	
	1	Plug, Kv 16			9613168501	
	1	Plug, Kv 44			9613158902	
	1	Plug, Kv 25			9613168502	
	1	Plug, Kv 9				9613168503
	1	Plug, Kv 30				9613168504
	1	Plug, Kv 51				9613168505
	1	Plug, Kv 75				9613158903
Plug, complete, DIN, EPDM (standard)						
	1	Plug, Kv 4			8010000830	
	1	Plug, Kv 6			8010000831	
	1	Plug, Kv 10			8010000832	
	1	Plug, Kv 14			8010014473	
	1	Plug, Kv 16			9613168509	
	1	Plug, Kv 25			9613168510	
	1	Plug, Kv 44			9613158908	
	1	Plug, Kv 9				9613168511
	1	Plug, Kv 30				9613168512
	1	Plug, Kv 51				9613168513
	1	Plug, Kv 75				9613158909
Plug, complete, ISO, HNBR (standard)						
	1	Plug, Kv 4			8010000845	
	1	Plug, Kv 6			8010000846	
	1	Plug, Kv 10			8010000847	
Plug, complete, ISO, HNBR						
	1	Plug, Kv 14			9613158913	
	1	Plug, Kv 16			9613168517	
	1	Plug, Kv 44			9613158914	
	1	Plug, Kv 25			9613168518	
	1	Plug, Kv 9				9613168519
	1	Plug, Kv 30				9613168520
	1	Plug, Kv 51				9613168521
	1	Plug, Kv 75				9613158915
Plug, complete, DIN, HNBR (standard)						
	1	Plug, Kv 4			8010000835	
	1	Plug, Kv 6			8010000836	
	1	Plug, Kv 10			8010000837	
Plug, complete, DIN, HNBR						
	1	Plug, Kv 14			8010014474	
	1	Plug, Kv 16			9613168525	
	1	Plug, Kv 25			9613168526	
	1	Plug, Kv 44			9613158920	
	1	Plug, Kv 9				9613168527
	1	Plug, Kv 30				9613168528
	1	Plug, Kv 51				9613168529
	1	Plug, Kv 75				9613158921

Unique RV-ST Regulating Valve (sizes 25mm-51 mm/DN25-DN50)

If the actuator is marked with a danger warning do **NOT** attempt to cut the actuator open.



Do **NOT** attempt to disassemble the actuator due to spring under load danger!

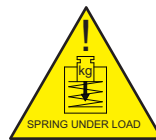

Do **NOT** attempt to cut the actuator open, due to spring under load danger!

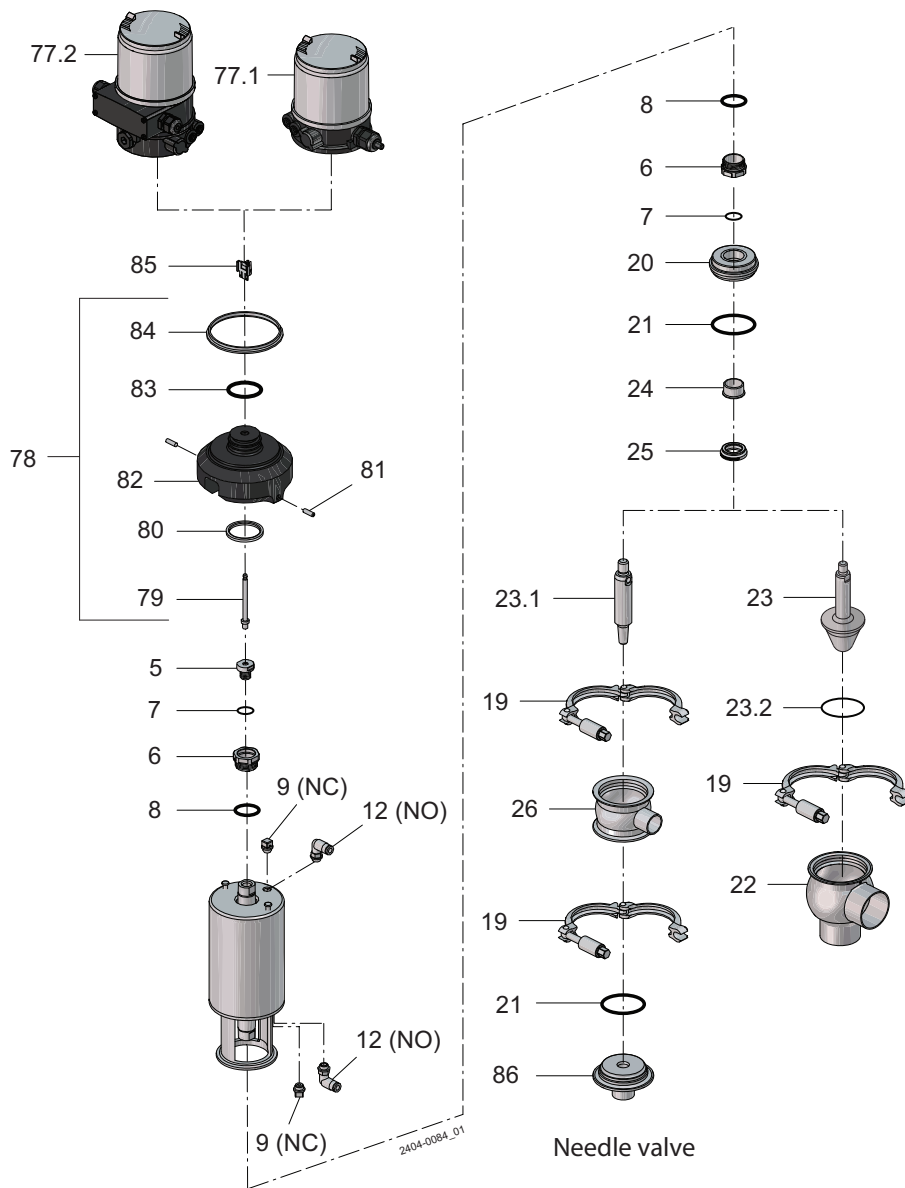

Unique RV-ST Regulating Valve (sizes 25mm-51mm/DN25-DN50)

Pos	Qty	Denomination	25 mm DN25 Needle	25 mm DN25 Standard	DN40 38 mm	DN50 51 mm
Plug, complete, DIN, HNBR						
23	1	Plug, Kv 14			8010014474	
	1	Plug, Kv 16			9613168525	
	1	Plug, Kv 25			9613168526	
	1	Plug, Kv 44			9613158920	
	1	Plug, Kv 9				9613168527
	1	Plug, Kv 30				9613168528
	1	Plug, Kv 51				9613168529
	1	Plug, Kv 75				9613158921
Plug, complete, ISO, FPM (standard)						
	1	Plug, Kv 4			8010000838	
	1	Plug, Kv 6			8010000840	
	1	Plug, Kv 10			8010000841	
Plug, complete, ISO, FPM						
	1	Plug, Kv 14			9613158925	
	1	Plug, Kv 16			9613168533	
	1	Plug, Kv 25			9613168534	
	1	Plug, Kv 44			9613158926	
	1	Plug, Kv 9				9613168535
	1	Plug, Kv 30				9613168536
	1	Plug, Kv 51				9613168537
	1	Plug, Kv 75				9613158927
Plug, complete, DIN, FPM (standard)						
	1	Plug, Kv 4			8010000838	
	1	Plug, Kv 6			8010000840	
	1	Plug, Kv 10			8010000841	
Plug, complete, DIN, FPM						
	1	Plug, Kv 14			8010014475	
	1	Plug, Kv 16			9613168541	
	1	Plug, Kv 25			9613168542	
	1	Plug, Kv 44			9613158932	
	1	Plug, Kv 9				9613168543
	1	Plug, Kv 30				9613168544
	1	Plug, Kv 51				9613168545
	1	Plug, Kv 75				9613158933
23.1	1	Plug, ISO, Kv 4			8010000545	
	1	Plug, ISO, Kv 6			8010000546	
	1	Plug, ISO, Kv 10			8010000547	
	1	Plug, ISO, Kv 14			9613158801	
	1	Plug, ISO, Kv 16			9613165001	
	1	Plug, ISO, Kv 25			9613165002	
	1	Plug, ISO, Kv 44			9613158802	
	1	Plug, DIN, Kv 4			9615482401	
	1	Plug, DIN, Kv 6			9615482301	
	1	Plug, DIN, Kv 10			9615482201	
	1	Plug, DIN, Kv 14			8010014472	
	1	Plug, DIN, Kv 16			8010014477	
	1	Plug, DIN, Kv 25			9613165010	
	1	Plug, DIN, Kv 44			9613158808	
	1	Plug, ISO, Kv 9				9613165003
	1	Plug, ISO, Kv 30				9613165004
	1	Plug, ISO, Kv 51				9613165005
	1	Plug, ISO, Kv 75				9613158803
	1	Plug, DIN, Kv 9				9613165011
	1	Plug, DIN, Kv 30				9613165012
	1	Plug, DIN, Kv 51				9613165013
	1	Plug, DIN, Kv 75				9613158809
23.2	1	Plug seal, EPDM (standard)				
	1	Plug seal, HNBR				
	1	Plug seal, FPM				
		Plug seal, set (10 pcs.) EPDM			9614059404	9614059407
		Plug seal, set (10 pcs.) HNBR			9614059405	9614059408
		Plug seal, set (10 pcs.) FPM			9614059406	9614059409

Unique RV-ST Regulating Valve (sizes 25mm-51 mm/DN25-DN50)

If the actuator is marked with a danger warning do **NOT** attempt to cut the actuator open.



Do **NOT** attempt to disassemble the actuator due to spring under load danger!

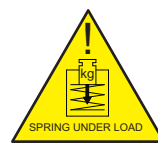

Do **NOT** attempt to cut the actuator open, due to spring under load danger!

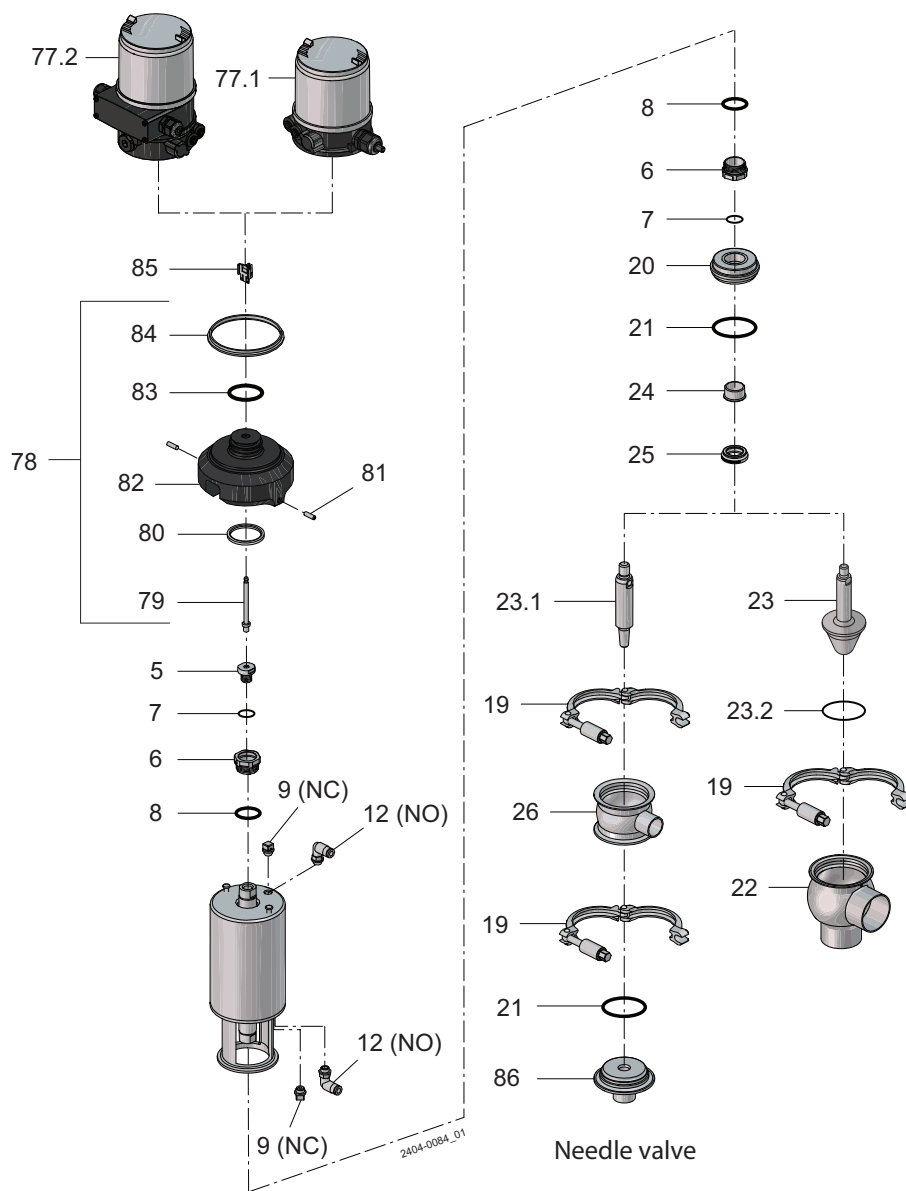

Unique RV-ST Regulating Valve (sizes 25mm-51mm/DN25-DN50)

Service kits

		25 mm DN25 Needle	25 mm DN25 Standard	DN40 38 mm	DN50 51 mm
□	Service kit, actuator	9611926500	9611926500	9611926500	9611926500
Service kits for product wetted parts					
♦	Service kit, EPDM	9611926958	9611926961	9611926502	9611926503
♦	Service kit, HNBR	9611926959	9611926962	9611926508	9611926509
♦	Service kit, FPM	9611926960	9611926963	9611926514	9611926515

Parts marked with □ are included in the service kits (actuator)

Parts marked with ♦ are included in the service kits (product wetted parts)

TD 900618/8

Unique RV-ST Regulating Valve (sizes 63.5 mm-101.6 mm/DN65-DN100)

If the actuator is marked with a danger warning do **NOT** attempt to cut the actuator open.



Do **NOT** attempt to disassemble the actuator due to spring under load danger!

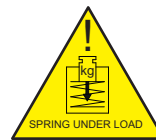

Do **NOT** attempt to cut the actuator open, due to spring under load danger!

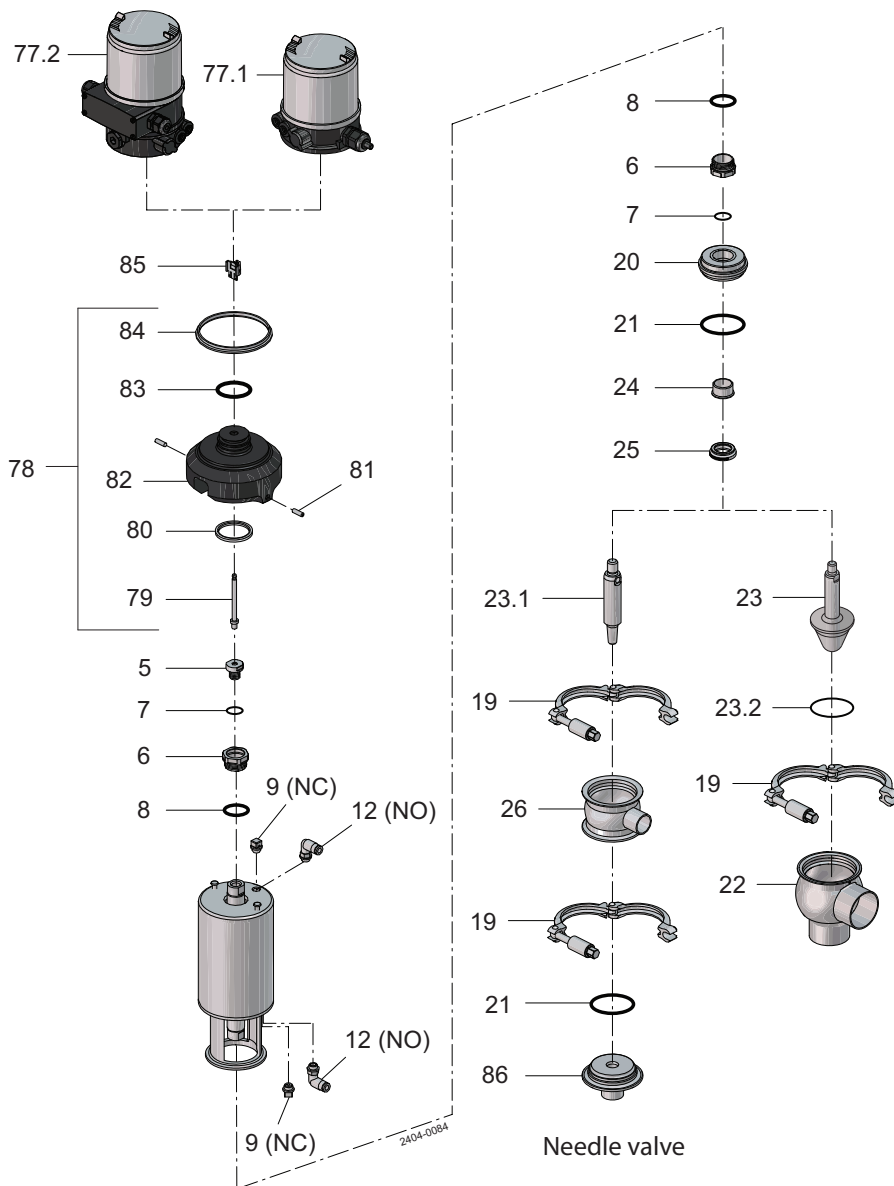

Unique RV-ST Regulating Valve (sizes 63.5 mm-101.6 mm/DN65-DN100)

Pos	Qty	Denomination	63.5 mm DN65	76.1 mm DN80	101.6 mm DN100
Actuator					
		Actuator, complete (NO)	9613154803	9613154804	9613154805
		Actuator, complete (NC)	9613154808	9613154809	9613154810
		Actuator, complete (NO) - US	9613154848	9613154849	9613154850
		Actuator, complete (NC) - US	9613154853	9613154854	9613154855
6	2	Bushing			
7	2	O-ring			
8	2	O-ring			
9	1	Plug	9613414101	9613414101	9613414101
12	1	Air fitting	9611991988	9611991988	9611991988
	1	Air fitting - US	9611994682	9611994682	9611994682
76	1	Positioner 8694 (incl. Pos. 77 to 85) - without display	9611995266	9611995266	9611995266
	1	Positioner 8692 (incl. Pos. 77 to 85) - with display	9611995268	9611995268	9611995268
	1	Positioner 8694 (incl. Pos. 77 to 85) - US - without display	9634085943	9634085943	9634085943
	1	Positioner 8692 (incl. Pos. 77 to 85) - US - with display	9634085944	9634085944	9634085944
77.1	1	Positioner 8694 without display			
	1	Positioner 8692 with display			
77.2	1	Positioner 8694 without display - US			
	1	Positioner 8692 with display - US			
78	1	Adapter, cpl. (incl. Pos. 79 to 84)	9611995337	9611995337	9611995337
79	1	Spindle			
80	1	Special X-ring	9612569601	9612569601	9612569601
81	2	Allen screw	9611993409	9611993409	9611993409
82	1	Adapter			
83	1	O-ring	9611995273	9611995273	9611995273
84	1	Gasket for adapter	9611995274	9611995274	9611995274
85	1	Puck sensorpad, cpl.	9611995275	9611995275	9611995275
Clamp					
19	2	Clamp			
	1	Clamp	9612939305	9612939306	9612939307
Bonnet					
20	1	Bonnet	9613127104	9613127105	9613127106
21	◆ 2	O-ring, EPDM (standard)			
	◆ 2	O-ring, HNBR			
	◆ 2	O-ring, FPM			
	◆ 1	O-ring, EPDM (standard)			
	◆ 1	O-ring, HNBR			
	◆ 1	O-ring, FPM			
		O-ring, set (10 pcs.), EPDM	9614059428	9614059431	9614059434
		O-ring, set (10 pcs.), HNBR	9614059429	9614059432	9614059435
		O-ring, set (10 pcs.), FPM	9614059430	9614059433	9614059436
24	1	Bushing	9613125002	9613125002	9613125002
25	◆ 1	Lip seal, EPDM (standard)			
	◆ 1	Lip seal, HNBR			
	◆ 1	Lip seal, FPM			
	1	Lip seal, set (10 pcs.) EPDM	9614059419	9614059419	9614059419
	1	Lip seal, set (10 pcs.) HNBR	9614059420	9614059420	9614059420
	1	Lip seal, set (10 pcs.) FPM	9614059421	9614059421	9614059421
Valve body					
22	1	Valve body, lower, 2 ports ISO	9613139507	9613139509	9613139511
	1	Valve body, lower, 3 ports ISO	9613139508	9613139510	9613139512
	1	Valve body, lower, 2 ports DIN	9613139607	9613139609	9613139611
	1	Valve body, lower, 3 ports DIN	9613139608	9613139610	9613139612
	1	Valve body, lower, 2 ports, clamp - US	9613161659	9613161673	9613161687
	1	Valve body, lower, 3 ports, clamp - US	9613161668	9613161682	9613161696

Unique RV-ST Regulating Valve (sizes 63.5 mm-101.6 mm/DN65-DN100)

If the actuator is marked with a danger warning do **NOT** attempt to cut the actuator open.

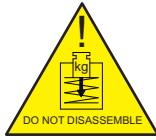

Do **NOT** attempt to disassemble the actuator due to spring under load danger!

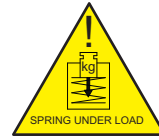

Do **NOT** attempt to cut the actuator open, due to spring under load danger!

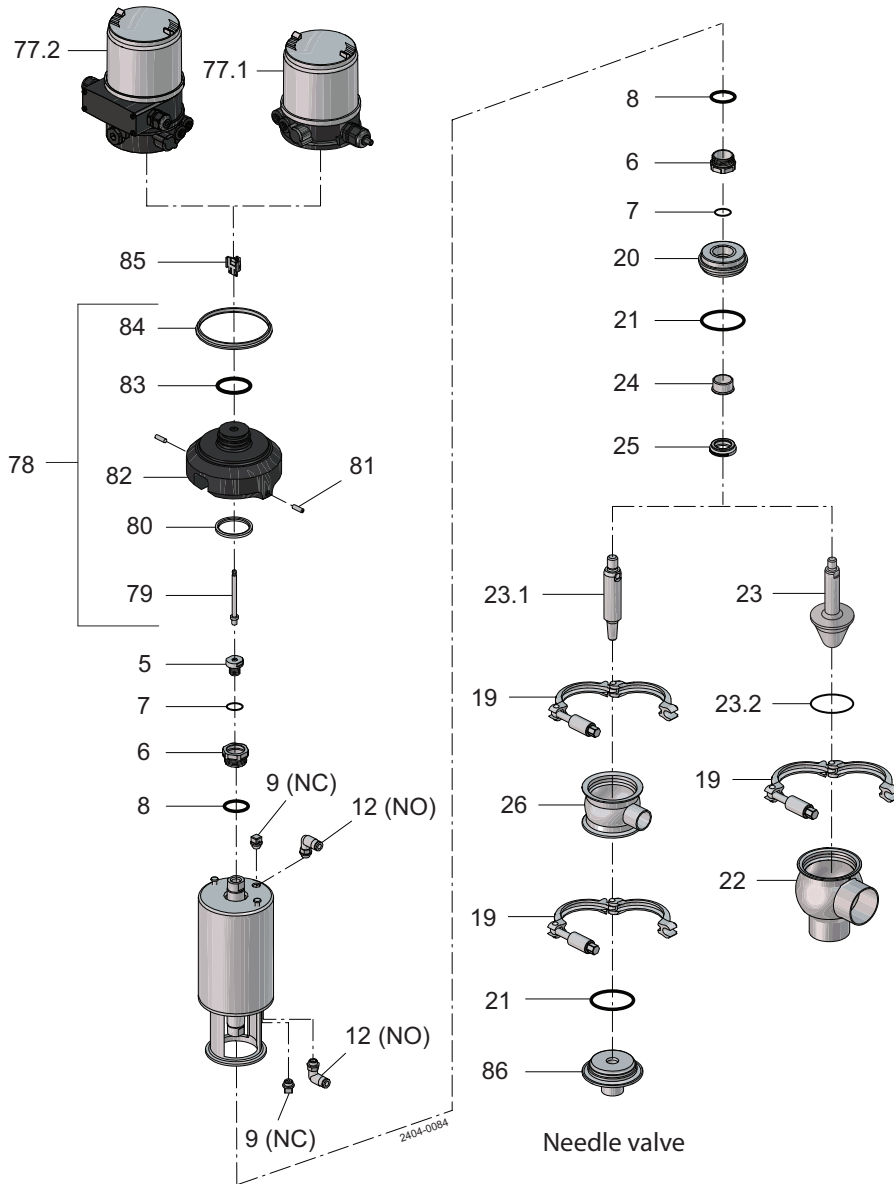

Unique RV-ST Regulating Valve (sizes 63.5 mm-101.6 mm/DN65-DN100)

Pos	Qty	Denomination	63.5 mm/ DN65	76.1 mm DN80	101.6 mm DN100
Plug, complete, ISO, EPDM (standard)					
23	1	Plug, Kv 26	9613168507		
	1	Plug, Kv 107	9613158904		
	1	Plug, Kv 59		9613168601	
	1	Plug, Kv 101		9613168508	
	1	Plug, Kv 172		9613158905	
	1	Plug, Kv 125			9613168602
	1	Plug, Kv 164			9613168603
	1	Plug, Kv 250			9613158906
Plug, complete, DIN, EPDM (standard)					
	1	Plug, Kv 26	9613168515		
	1	Plug, Kv 107	9613158910		
	1	Plug, Kv 59		9613168604	
	1	Plug, Kv 101		9613168516	
	1	Plug, Kv 172		9613158911	
	1	Plug, Kv 125			9613168605
	1	Plug, Kv 164			9613168606
	1	Plug, Kv 250			9613158912
Plug, complete, ISO, HNBR (standard)					
	1	Plug, Kv 26	9613168523		
	1	Plug, Kv 107	9613158916		
	1	Plug, Kv 59		9613168607	
	1	Plug, Kv 101		9613168524	
	1	Plug, Kv 172		9613158917	
	1	Plug, Kv 125			9613168608
	1	Plug, Kv 164			9613168609
	1	Plug, Kv 250			9613158918
Plug, complete, DIN, HNBR					
	1	Plug, Kv 26	9613168531		
	1	Plug, Kv 107	9613158922		
	1	Plug, Kv 59		9613168610	
	1	Plug, Kv 101		9613168532	
	1	Plug, Kv 172		9613158923	
	1	Plug, Kv 125			9613168611
	1	Plug, Kv 164			9613168612
	1	Plug, Kv 250			9613158924
Plug, complete, ISO, FPM					
	1	Plug, Kv 26	9613168539		
	1	Plug, Kv 107	9613158928		
	1	Plug, Kv 59		9613168613	
	1	Plug, Kv 101		9613168540	
	1	Plug, Kv 172		9613158929	
	1	Plug, Kv 125			9613168614
	1	Plug, Kv 164			9613168615
	1	Plug, Kv 250			9613158930
Plug, complete, DIN, FPM					
	1	Plug, Kv 26	9613168547		
	1	Plug, Kv 107	9613158934		
	1	Plug, Kv 59		9613168616	
	1	Plug, Kv 101		9613168548	
	1	Plug, Kv 172		9613158935	
	1	Plug, Kv 125			9613168617
	1	Plug, Kv 164			9613168618
	1	Plug, Kv 250			9613158936

Unique RV-ST Regulating Valve (sizes 63.5 mm-101.6 mm/DN65-DN100)

If the actuator is marked with a danger warning do **NOT** attempt to cut the actuator open.



Do **NOT** attempt to disassemble the actuator due to spring under load danger!

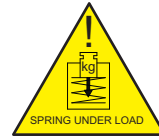

Do **NOT** attempt to cut the actuator open, due to spring under load danger!

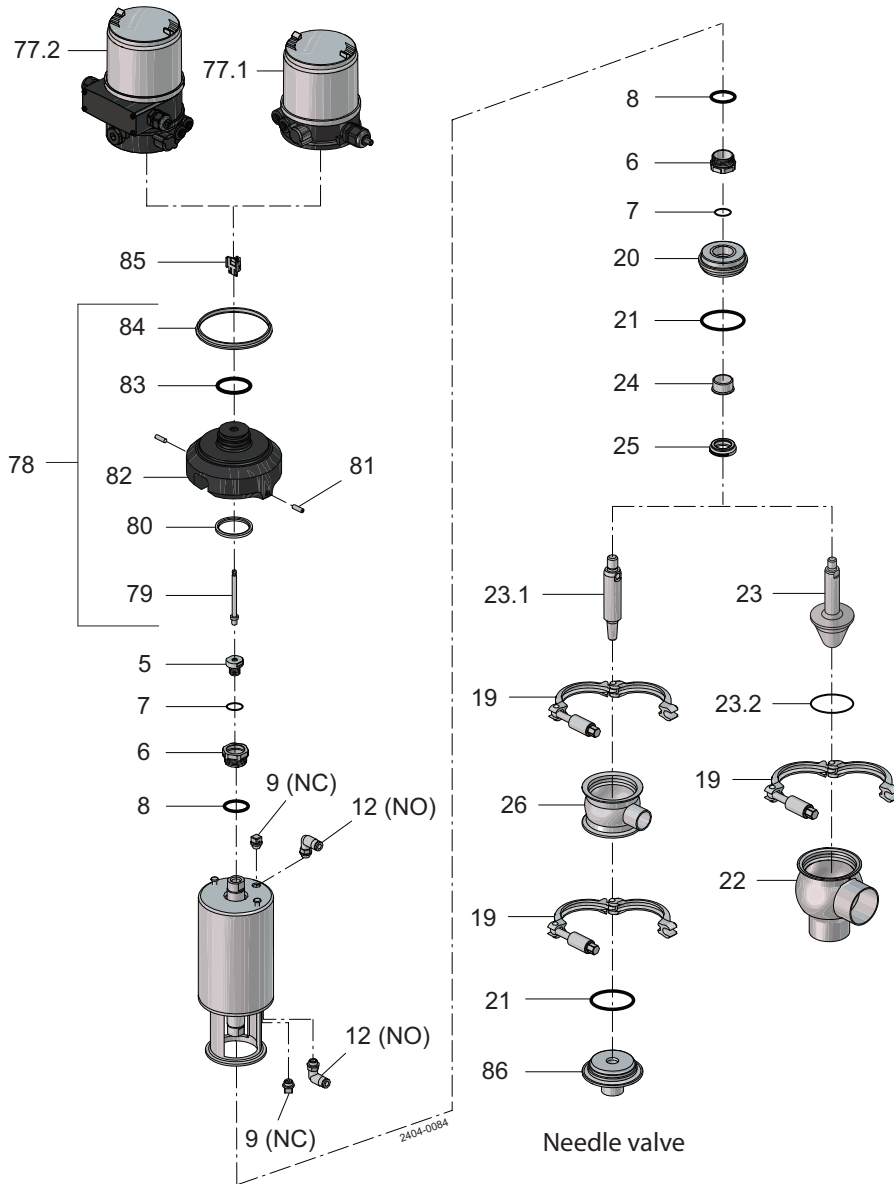

Unique RV-ST Regulating Valve (sizes 63.5 mm-101.6 mm/DN65-DN100)

Pos	Qty	Denomination	63.5 mm DN65	76.1 mm DN80	101.6 mm DN100
23.1	1	Plug, ISO, Kv 26	9613165007		
	1	Plug, ISO, Kv 107	9613158804		
	1	Plug, DIN, Kv 26	9613165015		
	1	Plug, DIN, Kv 107	9613158810		
	1	Plug, ISO, Kv 59		9613167001	
	1	Plug, ISO, Kv 101		9613165008	
	1	Plug, ISO, Kv 172		9613158805	
	1	Plug, DIN, Kv 59		9613167004	
	1	Plug, DIN, Kv 101		9613165016	
	1	Plug, DIN, Kv 172		9613158811	
	1	Plug, ISO, Kv 125			9613167002
	1	Plug, ISO, Kv 164			9613167003
	1	Plug, ISO, Kv 250			9613158806
	1	Plug, DIN, Kv 125			9613167005
	1	Plug, DIN, Kv 164			9613167006
	1	Plug, DIN, Kv 250			9613158812
	23.2♦	1	Plug seal, EPDM (standard)		
1		Plug seal, HNBR			
1		Plug seal, FPM			
1		Plug seal, set (10 pcs.) EPDM	9614059410	9614059413	9614059416
1		Plug seal, set (10 pcs.) HNBR	9614059411	9614059414	9614059417
	1	Plug seal, set (10 pcs.) FPM	9614059412	9614059415	9614059418

Recommended spare parts: Service kits

Service kits

		63.5 mm DN65	76.1 mm DN80	101.6 mm DN100
□	Service kit, actuator	9611926500	9611926500	9611926500
Service kits for product wetted parts				
♦	Service kit, EPDM	9611926504	9611926505	9611926506
♦	Service kit, HNBR	9611926510	9611926511	9611926512
♦	Service kit, FPM	9611926516	9611926517	9611926518

Parts marked with □ are included in the service kits (actuator)

Parts marked with ♦ are included in the service kits (product wetted parts)

Tool for bushing (pos. 24) 9613160901

TD 900618/8

Maintainable actuator (sizes 25mm-51mm/DN25-DN50)

If the actuator is marked with a danger warning do **NOT** attempt to cut the actuator open.



Do **NOT** attempt to disassemble the actuator due to spring under load danger!

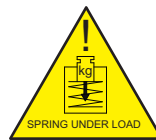

Do **NOT** attempt to cut the actuator open, due to spring under load danger!

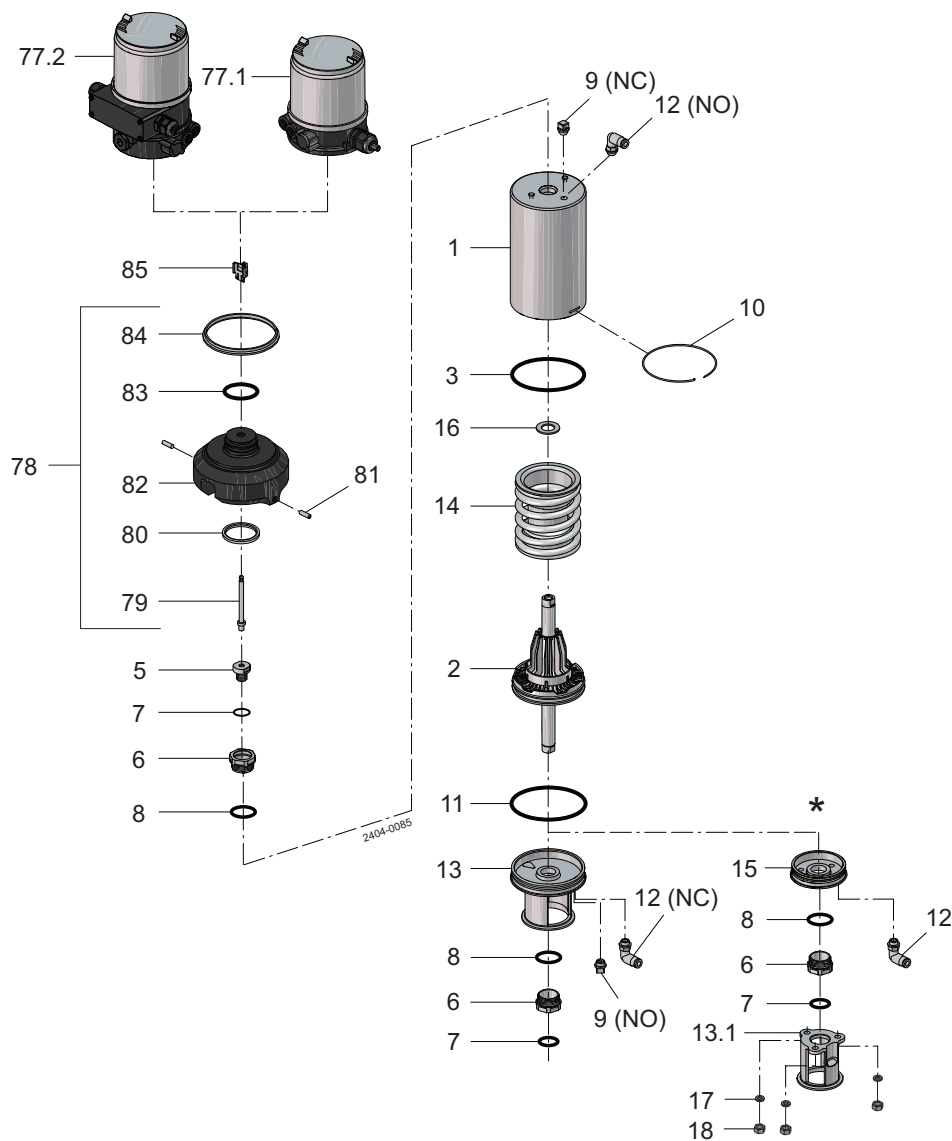

*) "Removable yoke bolts" version, product from 2006 to June 2016.
Replaced by "yoke without bolts" (13)

Maintainable actuator (sizes 25mm-51mm/DN25-DN50)

Pos	Qty	Denomination	25 mm	25 mm	DN40	DN50
			DN25 Needle	DN25 Standard	38 mm	51 mm
		Actuator, complete (NO)	9613185301	9613185301	9613185301	9613185302
		Actuator, complete (NC)	9613185306	9613185306	9613185306	9613185307
		Actuator, complete (A/A)				
		Actuator - US, complete (NO)	9613185346	9613185346	9613185346	9613185347
		Actuator - US, complete (NC)	9613185351	9613185351	9613185351	9613185352
		Actuator - US, complete (A/A)				
1	1	Cylinder	9613142511	9613142511	9613142511	9613142512
2	1	Piston	9613132201	9613132201	9613132201	9613132301
3	1	O-ring				
6	2	Bushing				
7	2	O-ring				
8	2	O-ring				
9	1	Plug, NO+NC	9613414101	9613414101	9613414101	9613414101
10	1	Lock wire	9613143201	9613143201	9613143201	9613143202
11	1	O-ring				
12	1	Air fitting, (NC)	9611991988	9611991988	9611991988	9611991988
13	1	Yoke without bolts (0616 -)	9613154301	9613154301	9613154301	96131544402
14	1	Spring assembly	9613132501	9613132501	9613132501	9613132502
16	1	Support disc				
76	1	Positioner 8694, (incl. pos. 77 to 85)	9611995266	9611995266	9611995266	9611995266
	1	Positioner 8692, (incl. pos. 77 to 85)	9611995268	9611995268	9611995268	9611995268
77.1	1	Positioner 8694 without display				
	1	Positioner 8692 with display				
77.2	1	Positioner 8694 without display - US				
	1	Positioner 8692 with display - US				
78	1	Adapter, cpl. (incl. Pos. 79 to 84)				
79	1	Spindle				
80	1	Special X-ring	9612569601	9612569601	9612569601	9612569601
81	2	Allen screw	9611993409	9611993409	9611993409	9611993409
82	1	Adapter				
83	1	O-ring	9611995273	9611995273	9611995273	9611995273
84	1	Gasket for adapter	9611995274	9611995274	9611995274	9611995274
85	1	Puck sensorpad, cpl.	9611995275	9611995275	9611995275	9611995275

Removeable yoke with bolts - OBSOLETE

use position 13

13.1	1	Yoke (- 0616)				
15	1	Bottom (- 0616)				
17	3	Washer (- 0616)				
18	3	Nut (- 0616)				

Parts marked with ● are included in the service kits for actuator.

Recommended spare parts: Service kits.

TD900-619/9

Service kits

		Denomination	25 mm	25 mm	DN40	DN50
			DN25 Needle	DN25 Standard	38 mm	51 mm
●		Service kit, actuator	9611926497	9611926497	9611926497	9611926498

Maintainable actuator (sizes 63.5 mm-101.6 mm/DN65-DN100)

If the actuator is marked with a danger warning do **NOT** attempt to cut the actuator open.



Do **NOT** attempt to disassemble the actuator due to spring under load danger!

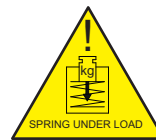

Do **NOT** attempt to cut the actuator open, due to spring under load danger!

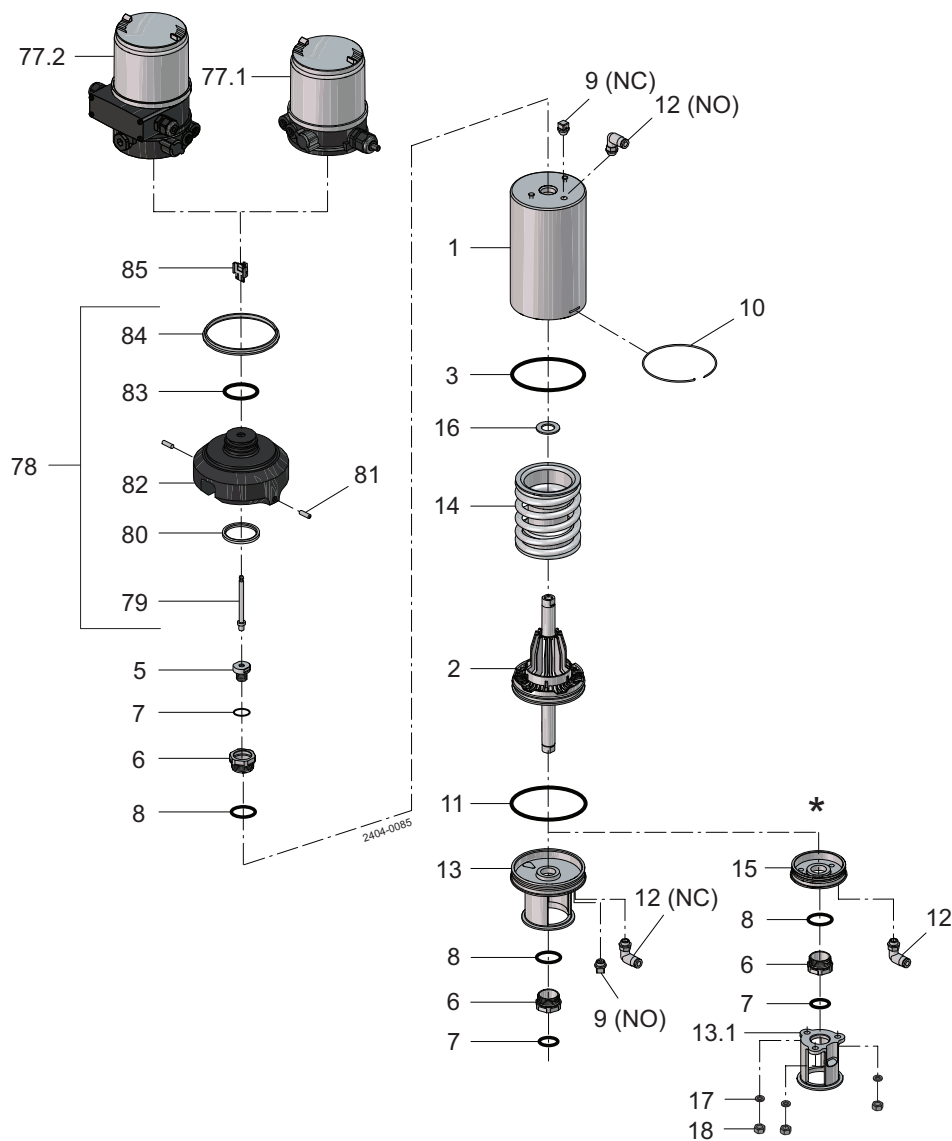

*) "Removable yoke bolts" version, product from 2006 to June 2016.
Replaced by "yoke without bolts" (13)

Maintainable actuator (sizes 63.5 mm-101.6 mm/DN65-DN100)

Pos	Qty	Denomination	63.5 mm DN65	76.1 mm DN80	101.6 mm DN100
		Actuator, complete (NO)	9613185303	9613185304	9613185305
		Actuator, complete (NC)	9613185308	9613185309	9613185310
		Actuator, complete (A/A)			
		Actuator, complete (A/A)	9613185313	9613185314	9613185315
		Actuator - US, complete (NO)	9613185348	9613185349	9613185350
		Actuator - US, complete (NC)	9613185353	9613185354	9613185355
		Actuator - US, complete (A/A)			
1	1	Cylinder	9613142512	9613142513	9613142513
2	1	Piston	9613132301	9613132401	9613132401
3	1	O-ring			
6	2	Bushing			
7	2	O-ring			
8	2	O-ring			
9	1	Plug, NO+NC	9613414101	9613414101	9613414101
10	1	Lock wire	9613143202	9613143203	9613143203
11	1	O-ring			
12	1	Air fitting, (NC)	9611991988	9611991988	9611991988
13	1	Yoke without bolts (0616 -)	9613154502	9613154603	9613154703
14	1	Spring assembly	9613132502	9613132503	9613132503
16	1	Support disc			
76	1	Positioner, 8694, (incl. pos. 77 to 85)	9611995266	9611995266	9611995266
	1	Positioner, 8692, (incl. pos. 77 to 85)	9611995268	9611995268	9611995268
77.1	1	Positioner 8694 without display			
	1	Positioner 8692 with display			
77.2	1	Positioner 8694 without display - US			
	1	Positioner 8692 with display - US			
78	1	Adapter, cpl. (incl. Pos. 79 to 84)			
79	1	Spindle			
80	1	Special X-ring	9612569601	9612569601	9612569601
81	2	Allen screw	9611993409	9611993409	9611993409
82	1	Adapter			
83	1	O-ring	9611995273	9611995273	9611995273
84	1	Gasket for adapter	9611995274	9611995274	9611995274
85	1	Puck sensorpad, cpl.	9611995275	9611995275	9611995275
	1	Puck sensorpad, cpl. (green)	9611995371	9611995371	9611995371

Removeable yoke with bolts - OBSOLETE

use position 13

13.1	1	Yoke (- 0616)			
15	1	Bottom (- 0616)			
17	3	Washer (- 0616)			
18	3	Nut (- 0616)			

Parts marked with ● are included in the service kits for actuator.

Recommended spare parts: Service kits.

TD900-619/9

Service kits

		63.5 mm DN65	76.1 mm DN80	101.6 mm DN100
●	Service kit, actuator	9611926498	9611926499	9611926499

How to contact Alfa Laval

Contact details for all countries are continually updated on our website.

Please visit www.alfalaval.com to access the information directly.

© Alfa Laval Corporate AB

This document and its contents is owned by Alfa Laval Corporate AB and protected by laws governing intellectual property and thereto related rights. It is the responsibility of the user of this document to comply with all applicable intellectual property laws. Without limiting any rights related to this document, no part of this document may be copied, reproduced or transmitted in any form or by any means (electronic, mechanical, photocopying, recording, or otherwise), or for any purpose, without the expressed permission of Alfa Laval Corporate AB. Alfa Laval Corporate AB will enforce its rights related to this document to the fullest extent of the law, including the seeking of criminal prosecution.