

Product Recovery System

Installation, Operation, and Maintenance Manual



Safety

Important Safety Information

READ THIS MANUAL carefully to learn how to install, operate, and maintain this equipment. Failure to do so could result in personal injury and/or equipment damage.

Safety is very important!

DO NOT attempt to modify any TrueClean product. Doing so could create unsafe conditions, and would void all warranties.

DO NOT place any TrueClean product in an application where general product service ratings are exceeded.

The words **DANGER**, **WARNING**, and **CAUTION** and their meanings, as used within these instructions, are below.

- **Danger:** Indicates an imminently hazardous situation which, if not avoided, will result in death or serious injury. The word Danger is used in the most extreme cases.
- **Warning:** Indicates a potentially hazardous situation which, if not avoided, could result in death or serious injury.
- **Caution:** Indicates a potentially hazardous situation which, if not avoided, may result in minor or moderate injury. This may also be used to alert against an unsafe operating or maintenance practice.

Do not remove any labeling on any TrueClean product. Immediately replace any label that is missing.

Product Recovery

Table of Contents

Safety	2
Important Safety Information	2
Introduction	5
About This Manual	6
Application	7
Technical Data	7
Air Flow Requirements	7
Optional In-Line Flow Meter	8
Warranty	8
Built-in Safety	9
Installation	10
Optional Control Cabinet Mounting Bracket	11
Disclaimer of Liability	11
Air Connections	12
Wiring Locations	13
Basic Push Button Control System Cabinet	13
Basic Touch Screen Control System Cabinet	14
Automated Return Control System - Main Cabinet	16
Automated Return Control System - Remote Cabinet	17
Operation	18
Basic Control Panel	18
Launch Cycle	18
Automated Return Control Panel	19
Launch Cycle	19
Return Cycle	20

Table of Contents Continues on next page

Product Recovery

Table of Contents (cont.)

Maintenance	21
Monthly Checklist	21
Replacing Components	22
Replacing “Poly” Tubing	22
Replacing Supply Hoses	23
Replacing Pressure Regulator Filter Element	23
Replacing Solenoid Valve	25
Configuration	26
Automated Control System	26
Configuration Options Explained	28
Basic Control Panel Parts List	30
Troubleshooting	31
Customer Specific Configuration	32
Customer Notes	33
Basic Install Example	34
Returning Install Example	35

Introduction

Thank you for purchasing a TrueClean Product!

This manual contains installation, operation, and maintenance instructions for TrueClean's Product Recovery Control Systems.

About This Manual

This manual covers the complete line of TrueClean's Product Recovery Control Systems. All Product Recovery Control Systems are available with optional equipment that can provide additional functionality.

There may be as many as three separate sets of instructions for similar tasks in this manual, depending on which particular Product Recovery Control System you own. We have made every effort to identify which instructions go with which control system. In general, these instructions will be very similar.

The Product Recovery Control Systems are designed to need little in the way of routine maintenance, but care and attention should be given to the instructions provided in this manual.

If, at any point, you have questions or concerns regarding your Product Recovery Control System, please contact your TrueClean distributor.

Introduction

WARRANTY:

A. **GENERAL PROVISIONS:** Central States Industrial Equipment & Service Inc. (hereinafter referred to as the Company) warrants to the original purchaser-used (hereinafter referred to as the Customer) that equipment or parts thereof manufactured by it will be free from defects in material and workmanship only, under normal use and service, for a period of one (1) year from the original shipment date. The Company shall not be liable for any loss of profit, loss by reason of plant shutdown, non-operation or increased cost of operation, loss product or materials, or other special or consequential loss or damages. This warranty will not apply to any equipment (or parts thereof) which has been subjected to accident, alteration, abuse or misuse. This warranty is in lieu of all other warranties, expressed or implied (including the implied warranty of merchantability and fitness) and of all other obligations or liabilities on the part of the Company, and the Company will neither assume nor authorize any other person to assume for it any other obligation or liability in connection with this equipment. In the event of a breach of warranty our liability shall be limited to the purchase price of the part(s) that have failed.

B. **RETURN OF PARTS OR EQUIPMENT TO COMPANY PLANT:** Permission to return any parts or equipment must be obtained, in writing, and must be returned with transportation cost prepaid. In the event that equipment (or parts thereof) manufactured by the Company is returned to the plant, the Companies obligation will be limited to repairing or replacing parts which upon examination are found (to the satisfaction of the Company) to be defective in either material or workmanship. No transportation will be paid by the Company unless written approval for transportation charges is given by the Company.

C. **COMPONENTS NOT MANUFACTURED BY THE COMPANY:** Components not manufactured by the Company, but furnished as part of its equipment (for example: Valves, controls, gauges, electrical switches or instruments, etc.) will be warranted by the Company only to the extent of the Component manufacturer's warranty.

D. **REPAIR OF EQUIPMENT INSTALLED IN THE CONTINENTAL UNITED STATES:** Should an in-warranty failure occur, and it is, in the judgement of the Company, impractical to return the equipment for repairs, the Company will arrange for the repairs to be made by its personnel or, at its option, sublet to a qualified company. The Customer will be expected to cooperate by making the equipment available and accessible when the work is scheduled and is expected to provide the necessary utilities. If local labor conditions prohibit such work being done by Company personnel under the conditions and at the rates payable by its contracts with its employees, the Company obligation shall be limited to supervision of the work, replacement of defective parts, and labor costs in an amount equal to the amount which would be payable for a reasonable number of hours required to make the repairs at the rates payable under the terms of Company contracts with its employees. In such event, all labor costs shall be paid by the Customer and the Company will reimburse him to the extent set forth above.

E. **REPAIR OF EQUIPMENT INSTALLED OUTSIDE THE CONTINENTAL UNITED STATES:** Should an in-warranty failure occur, and it is, in the judgement of the Company, impractical to return the equipment for repairs, the Company obligation shall be limited, and the Company shall have the options of either sending a service representative to repair (or supervise the repairs) or granting a reasonable allowance for having the repairs made locally.

Introduction

Application

Product recovery systems used to require extensive trial and error before new systems were properly tuned, with many customers abandoning the project due to frustration and projectile failures. True-Clean's Control Systems come preconfigured for your application and should operate successfully out of the box.

TrueClean's Product Recovery Control Systems are a simple, economical, and efficient way to regulate the operation of your Product Recovery System. It takes the guess work out of setting up and controlling the start, stop, pressure, and proper airflow required to have a successful product recovery cycle.

Technical Data

- Maximum compressed air pressure: 145 psig
- Temperature range: 0°F – 115°F
- Air inlet size: 1/2" FNPT
- Electrical Requirement: AC 100-240V, 50-60Hz +/- 6%
- Projectile velocity should be 3–5 feet per second

Air Flow Requirements

For smooth operation, the air pressure and airflow settings of the Product Recovery Control Systems can vary depending on factors such as product viscosity and system backpressure. The following pressure and flow settings are the recommended settings for initial startup of your system. Adjustment of these settings may be required to achieve the appropriate performance for your application.

Line Size	Min. Pressure	Min. Air Flow
1.5"	60 PSI	9 SCFM
2"	60 PSI	17 SCFM
2.5"	60 PSI	28 SCFM
3"	60 PSI	41 SCFM
4"	60 PSI	73 SCFM

Introduction

Optional In-Line Flow Meter

An optional in-line flow meter can provide accurate flow metering for fluid viscosities up to 500 SSU and can be mounted horizontally, vertically, or inverted. This in-line flow meter performs best with air, water, or caustic fluids, and is accurate to within 2.5%.

- 2" x ½" Female NPT dry seal
- Rated for 10-100 SCFM of flow
- Part number HFA-2-004

Note: TrueClean and the manufacturer of the components used recommend that the cabinet be supplied with clean process air at the minimum pressure and flow for your application.

Warranty

Seller warrants its products to be free from defect in materials and workmanship for a period of one (1) year from the date of shipment. This warranty shall not apply to products which require repair or replacement due to normal wear and tear or to products which are subjected to accident, misuse or improper maintenance. This warranty extends only to the original Buyer. Products manufactured by others but furnished by Seller are exempted from this warranty and are limited to the original manufacturer's warranty.

Seller's sole obligation under this warranty shall be to repair or replace any products that Seller determines, in its discretion, to be defective. Seller reserves the right either to inspect the products in the field or to request their prepaid return to Seller.

Seller shall not be responsible for any transportation charges, duty, taxes, freight, labor or other costs. The cost of removing and/or installing products which have been repaired or replaced shall be at Buyer's expense.

Seller expressly disclaims all other warranties, express or implied, including without limitation any warranty of merchantability of fitness for a particular purpose. The foregoing sets forth Seller's entire and exclusive liability, and Buyer's exclusive and sole remedy, for any claim of damages in connection with the sale of products. In no event shall Seller be liable for any special consequential incidental or indirect damages (including without limitation attorney's fees and expenses), nor shall Seller be liable for any loss of profit or material arising out of or relating to the sale or operation of the products based on contract, tort (including negligence), strict liability or otherwise.

Introduction

Built-in Safety

One important aspect of TrueClean's Product Recovery Control package is the built-in safety. Each control unit has integrated safety features including air lockout and emergency stop capabilities. The control units can also incorporate system timeouts and automated pressure relief for added safety with regards to operator use.

Air Lockout Capability

- When the air is in the off position a pad lock can be attached to the air switch to prevent accidental operation.
- This complies with OSHA lockout tag out procedures.



E-Stop Capability

- When the E-stop is activated all operations are stopped and the light illuminates.
- To release the E-stop twist in a clockwise rotation until it pops up.
- You will need to reset the system to continue with a launch.

Installation

Mount cabinet in accordance with appropriate specifications, as determined by the conditions of the mounting location. Some of these specifications may be called out by NEMA, UL, CSA, etc.

If required, a licensed contractor should be consulted prior to installation. One such range of specifications is UL 8.43, UL 8.44, and UL 8.45, which describe the mount cabinet according to UL 8.43, UL 8.44, or UL 8.45 specifications.



Installation

Optional Control Cabinet Mounting Bracket

If the optional mounting feet are desired, purchase item number EH-40320 with your control system.

1. Insert mounting foot studs into pre-drilled holes and turn enclosure upright.
2. Press the sealing washer onto the mounting foot stud, with the tapered cone towards the hole, and add flat washer.
3. Thread the nut onto mounting foot stud, and tighten it to 200 in·lb.

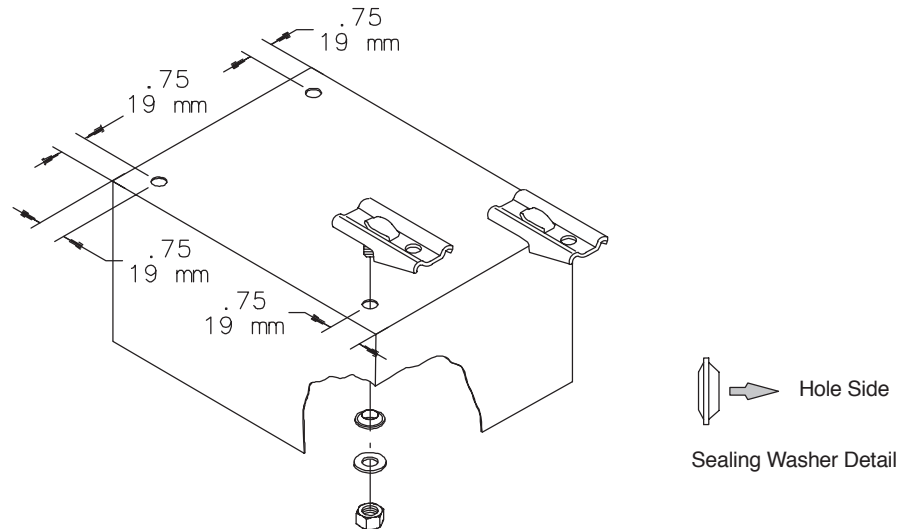

Disclaimer of Liability

TrueClean does not assume responsibility and expressly disclaims liability for loss, damage, or expenses that arise in any way from the installation, operation, use, or maintenance performed in accordance with this manual. TrueClean assumes no responsibility for any infringement of patents or other rights of third parties that may result from use of the module. No license is granted by implication or otherwise under any patent or patent rights.

TrueClean reserves the right to make changes to the product, specifications, or this manual without prior notice.

Installation

Air Connections

TrueClean's Product Recovery Control Panels are designed to be easy to install and intuitive to operate. It is recommended that Teflon tape, or a similar thread sealing compound, be used to eliminate air leakage at threaded air connections. Incoming plant air is connected at the cabinet input, and then from the exit of the cabinet to the launcher.

Air Input to Cabinet

- Air connection 1/2" NPT Female
- Supply with clean process air.

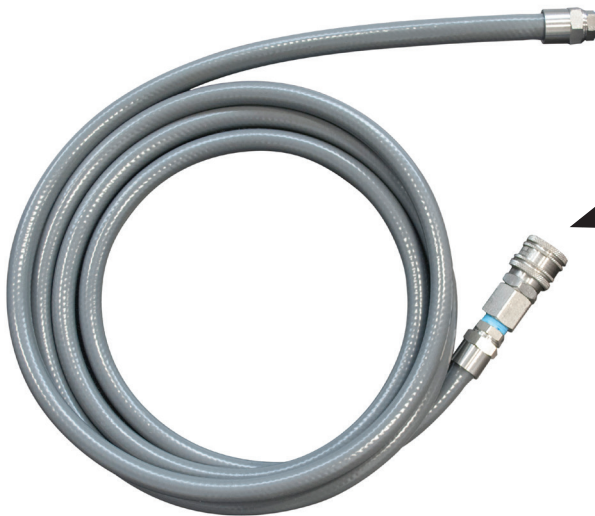

Air Supply to Launcher

- When purchased with a system the hose will be configured to match the connection at the launcher.
- Standard hose length is 10 feet.

Note: TrueClean and the manufacturer of the equipment recommends that the cabinet be supplied with clean process air at the minimum pressure and flow rate for your application.

Installation

Wiring Locations

Warning: To avoid electrical shock, ALL electrical work should be done by a registered electrician, following industrial safety standards and local codes. All power must be **OFF** and **Locked Out** during installation.

Below you will find several schematics, each of which has an explanation as to the type of system it refers to. The schematics will typically deal with providing power to either the Product Recovery Control System main panel, sub panel, or sensor.

Basic Push Button Control System Cabinet

The following schematic indicates where the incoming electrical utilities should be landed inside the Basic Push Button Control System Cabinet.

- Supply cabinet with AC 100-240V, 50-60Hz +/- 6% per UL 508A.
- Terminate at locations shown in the table below.

Label	Description
L	110V AC Line
N	Neutral
GND	Earth Ground
GND	Earth Ground
+24V	24VDC (+)
0V	DC Common
0V	Sensor Ground (Blue)
1	Sensor Power (Brown)
2	Spare
3	Spare
4	Sensor Signal (Black)
5	Spare
6	Spare
7	Solenoid 1 (+)
8	Solenoid 2 (+)
9	Non-Relieving Solenoid (+)
10	Solenoid 1 (-)
11	Solenoid 2 (-)
12	Non-Relieving Solenoid (-)

Sensor Wiring Diagram

BN – 1 Sensor Power

BU – DCCOM Sensor Ground

BK – 4 Sensor Signal

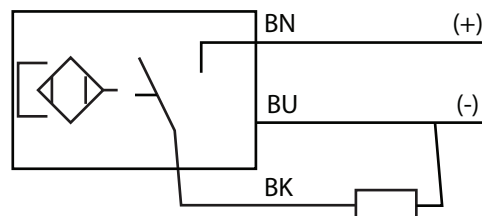

Installation

Basic Touch Screen Control System Cabinet

The following schematic indicates where the incoming electrical utilities should be landed inside the Basic Touch Screen Control System Cabinet.

- Supply cabinet with AC 100-240V, 50-60Hz +/- 6% per UL 508A.
- Terminate at locations shown in the table below.

Label	Description
L	110v AC Line
N	Neutral
GND	Earth Ground
GND	Earth Ground
GND	Earth Ground
(+24V)	24v DC (+)
0V	DC Common
1	Sensor Power (+) (Brown)
2	Remote Sensor Power (+) (Brown) **
3	PRS System Interlock (+)
4	Launch Valves Ready (+)
5	Return Valves Ready (+)
6	Drain Valve (+)
0V	Sensor Common (-) (Blue)
0V	Remote Sensor Common (-) (Blue) **
7	Sensor Input (Black)
8	Remote Sensor Signal (Black) **
9	PRS System Interlock Input
10	Launch Valves Ready Input
11	Return Valves Ready Input**
12	Drain Valve Input Input
13	Soloid Valve #1 Output
14	Soloid Valve #2 Output
15	Soloid Valve #3 Output
16	Remote Soloid Valve #1 Output **
17	Remote Soloid Valve #2 Output **

Sensor Wiring Diagram

BN – 1 Sensor Power
 BU – DCCOM Sensor Ground
 BK – 4 Sensor Signal

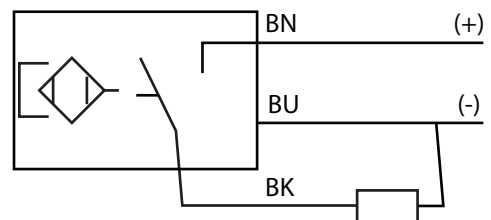

Installation

Basic Touch Screen Control System (cont.)

Label	Description
18	Remote Solinoid Valve #3 Output **
19	Cycle Complete Output
20	PRS System Active Output
21	Launch Request Output
22	Return Request Output**
23	Solinoid Valve #1 Common
24	Solinoid Valve #2 Common
25	Solinoid Valve #3 Common
26	Remote Solinoid Valve #1,2,3 Common **
27	Cycle Complete Common
28	PRS System Active Common
29	Launch Request Common
30	Return Request Common**

Sensor Wiring Diagram

BN – 1 Sensor Power

BU – DCCOM Sensor Ground

BK – 4 Sensor Signal

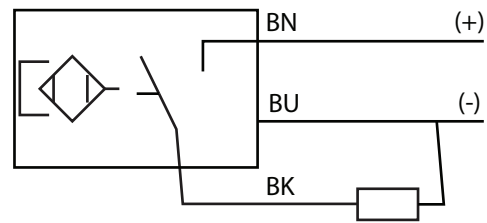

** The items marked in the table above indicate the wiring locations that are not used with a Basic Touch Screen Control System. The control system can be upgraded to the Automated Return version, and for this reason the terminal locations are present.

Installation

Automated Return Control System – Main Cabinet

Label	Description
L	110v AC Line
N	Neutral
GND	Earth Ground
GND	Earth Ground
GND	Earth Ground
(+24V)	24v DC (+)
0V	DC Common
1	Sensor Power (+) (Brown)
2	Remote Sensor Power (+) (Brown)
3	PRS System Interlock (+)
4	Launch Valves Ready (+)
5	Return Valves Ready (+)
6	Drain Valve (+)
0V	Sensor Common (-) (Blue)
0V	Remote Sensor Common (-) (Blue)
7	Sensor Input (Black)
8	Remote Sensor Signal (Black)
9	PRS System Interlock Input
10	Launch Valves Ready Input
11	Return Valves Ready Input
12	Drain Valve Input Input
13	Solinoid Valve #1 Output
14	Solinoid Valve #2 Output
15	Solinoid Valve #3 Output
16	Remote Solinoid Valve #1 Output
17	Remote Solinoid Valve #2 Output

Sensor Wiring Diagram

BN – 1 Sensor Power

BU – DCCOM Sensor Ground

BK – 4 Sensor Signal

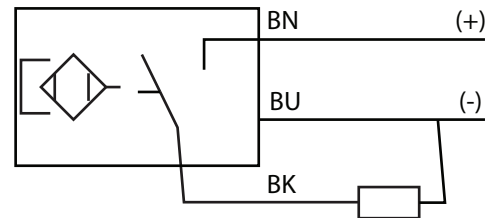

Installation

Automated Return Control System – Main Cabinet (cont.)

18	Remote Solinoid Valve #3 Output
19	Cycle Complete Output
20	PRS System Active Output
21	Launch Request Output
22	Return Request Output
23	Solinoid Valve #1 Common
24	Solinoid Valve #2 Common
25	Solinoid Valve #3 Common
26	Remote Solinoid Valve #1,2,3 Common
27	Cycle Complete Common
28	PRS System Active Common
29	Launch Request Common
30	Return Request Common

Automated Return Control System – Remote Cabinet

The landing positions from the main cabinet to the remote cabinet are noted below, along with an image of the remote cabinet's terminal block.

- Supply cabinet with AC 100-240V, 50-60Hz +/- 6% per UL 508A.
- Terminate at locations shown in the figure below.

Label	Description
GND	Earth Ground
GND	Earth Ground
2	Remote Sensor Power (+) (Brown)
0V	Remote Sensor Common (-) (Blue)
8	Remote Sensor Signal (Black)
16	Remote Solinoid Valve #1 Output
17	Remote Solinoid Valve #2 Output
18	Remote Solinoid Valve #3 Output
26	Remote Solinoid Valve #1 Common
26	Remote Solinoid Valve #2 Common
26	Remote Solinoid Valve #3 Common

Sensor Wiring Diagram

BN – 1 Sensor Power
 BU – DCCOM Sensor Ground
 BK – 4 Sensor Signal

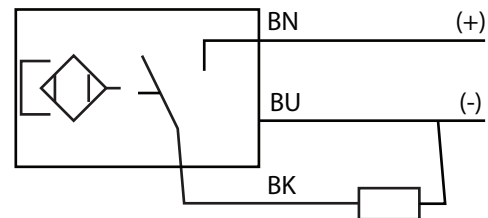

Operation

Basic Control Panel

In this section, you will find instructions regarding the launching of a product recovery projectile through the use of your basic push button control panel. Operators should take a moment to familiarize themselves with the items in bold below.

Launch Cycle

1. Verify the Product Recovery Projectile is in the Launcher and ready for launch
 - The projectile should be inserted into the run of the launcher until flush with the ferrule face
 - The air blow check valve can then be installed which will make sure the projectile is inserted no further than necessary

Note: Inserting the projectile too far could result in the projectile prematurely entering the process flow
2. Verify the Air Relief Switch is in the On position
3. Press the Reset System button
4. Hold the Start button down for 3 seconds to launch
5. Once the projectile has reached the sensor, the control panel will automatically shut the air off, and the Cycle Complete (amber) light will illuminate
6. Remove the Product Recovery Projectile from the catcher.
7. Once projectile and piping has been cleaned, the projectile can be reinstalled in the run of the launcher
 - If you try to launch the system again without resetting, the Cycle Complete (amber) light will blink, letting you know the system has not been reset.
 - Please see additional troubleshooting steps in the troubleshooting section of this manual.

Please Note: When contacting your TrueClean distributor, please provide your representative with the following information: Product viscosity, system line size, air pressure, airflow.

If the airflow is unknown, the optional in-line flow meter, in the Introduction section of this manual, can be purchased for diagnostic purposes.

If you have any questions about your Product Recovery System, please contact your TrueClean distributor.

Operation

Automated Return Control Panel

In this section, you will find instructions regarding the launching and/or returning of a product recovery projectile through the use of your automated return control panel. Operators should take a moment to familiarize themselves with the items in bold below.

Launch Cycle

1. Verify the Product Recovery Projectile is in the Launch position.

- The projectile should be inserted into the launcher until flush with the ferrule face
- The air blow check valve can then be installed which will make sure the projectile is inserted no further than necessary

Note: Inserting the projectile too far could result in the projectile prematurely entering the process flow

2. Press the Reset System button. The status should now be System Idle.

3. Press the Launch Request button. This will enable the launch cycle, and within a few seconds the status should change to Launch Ready.

Note: There are system level interlocks available which may require the Product Recovery Control Panel to wait for electrical acknowledgement from the plant level controller before proceeding. When enacted, this is a safety feature which should not be overridden.

4. Press the Go button for 3 Seconds to launch. The status will change to Launching.

Note: Once the Product Recovery Projectile has reached the sensor, the drain valve will be opened for a period of time determined by the length of the product recovery circuit. At this point, there should be no pressure in the line and the status will change to Launch Complete.

Operation

Return Cycle

1. Ensure the status indicates Launch Complete.

Note: If you try to Return or Launch the system without resetting, the status will say Reset System, letting you know the system has not been reset.

2. Press the Reset System button.

3. Press the Return Request button. This will enable the return cycle, and within a few seconds, the status should change to Return Ready.

Note: There are system level interlocks available which may require the Product Recovery Control Panel to wait for electrical acknowledgement from the plant level controller before proceeding. When enacted, this is safety feature which should not be overridden.

4. Press the Go button for 3 Seconds to launch. The status will change to Returning.

Note: Once the Product Recovery Projectile has reached the sensor, the drain valve will be opened for a period of time determined by the length of the product recovery circuit. At this point, there should be no pressure in the line and the status will change to Return Complete.

Please Note: When contacting TrueClean, please provide your representative with the following information: **Product viscosity, system line size, air pressure, airflow.**

If the airflow is unknown, the optional in-line flow meter, in the Introduction section of this manual, can be purchased for diagnostic purposes.

If you have any questions about your Product Recovery System, please contact your TrueClean distributor.

Maintenance

Warning: Operators should not perform maintenance on the Product Recovery Control Panel before ensuring a safe maintenance environment.

To ensure a safe environment, it is recommended, but not limited to, verifying the following precautions are met:

- Power to the control panel should be OFF and Locked Out
- Remove the inbound air supply from the pressure regulator

General cleanliness will extend the life of your control panels and its components. Where possible, the area should be kept free of spills and loose debris.

The product recovery projectile should be checked after each use for cracks or tears in the projectile. If the projectile is discovered to be cracked or torn, it should no longer be used, and a new projectile should be put into service.

Monthly Checklist:

- Check air lines for cracks and leaks
- Check pressure drop across filter
Note: The pressure drop should not exceed 14psig.
- Check for loose connections or connectivity concerns regarding the solenoid valves
Note: A solenoid valve will not likely give advanced warning before failing.

If any of the above issues exist, the Product Recovery Control Panel should not be used until they are resolved.

Maintenance

Replacing Components

TrueClean is providing general instructions regarding the replacement of components used in the manufacturing our Product Recovery Control System.

Replacing "Poly" Tubing

1. Disconnect the inbound airline at the pressure regulator and make certain Control Panel is powered down
2. Press the outer ring of the pneumatic fitting in, and then gently pull the cracked or leaking airline from the fitting
3. Repeat the same procedure for the other end of the airline.
4. Use the cracked or leaking airline as a guide for the length of the new airline
5. Trim the new section of airline to the appropriate length
6. Install airline by pressing each end into pneumatic fittings

Note: Make certain the outer rings on the pneumatic fittings extend after the new line is pressed in.

Maintenance

Replacing Supply Hoses

The hoses supplied by TrueClean are typically manufactured using reusable ends. In most cases, the ends will simply unscrew apart. A vice may be needed to gently hold the coupling during disassembly.

1. Disconnect the inbound airline at the pressure regulator and make certain Control Panel is powered down

2. Disconnect the damaged supply hose

3. While holding the collar stationary, unscrew the spool

Note: The collar is the piece that covers the hose, while the spool threads inside and press-fits the hose.

4. Repeat disassembly for the opposite end of hose

5. Cut the new piece of supply hose long enough to match application

Note: Hand pressure should be sufficient to push collar back onto each end of the hose.

6. Begin threading the spool by hand to keep the new hose from backing out and to help avoid cross-threading

Note: You may need a vice to hold the collar while completing the reassembly.

7. Repeat assembly for the opposite end of hose

Maintenance

Replacing Pressure Regulator Filter Element

The manufacturer of the supplied filter regulator recommends the filter element to be changed every two years, or when the pressure drop across the element exceeds 14 psig.

1. Locate the spring-loaded release on the front of the pressure regulator
2. Press the release down and hold
3. Turn the portion of the pressure regulator body below the release you are holding
 - This may be more easily accomplished by holding the release with the thumb of the hand with which you intend to turn the body
 - You should only need to turn the regulator body approximately half of a revolution before gently pulling it free

Note: If you only turn the body a quarter of a turn, the release may try to “snap” back into place.

4. Once the body of the regulator is removed, you will be able to remove the element and replace it
5. Put the body back on, and turn it back into position directly opposite of how you removed it

Maintenance

Replacing Solenoid Valve

The solenoid valves that TrueClean uses are rated for one million cycles, but there is not a performance guarantee for these items. While we do not offer a performance guarantee for the solenoid valves used, they are warranted, for a period of one year, to be free from manufacturer's defects.

1. Remove retaining screws from the existing solenoid valve and keep them until you are certain whether new screws were provided
2. Gently remove the solenoid valve from the mounting pad
 - Take note of how the solenoid valve is oriented
 - Take note of any and all O-rings, as there may be small O-rings on sealing surfaces
 - In some cases the top or bottom of the solenoid valve may need to come out first
3. Verify the O-rings are properly located on the new solenoid valve
4. It may be necessary to insert or seat one end of the solenoid valve before the other end will gently sit

Note: It should never be necessary to force the new solenoid valve into place.

5. Install the retaining screws that you removed in step (1). If new retaining screws were provided, use them and discard the screws from step (1)

Please Note: If at any point you have questions or concerns regarding your Product Recovery Auto Return Control System, please contact your TrueClean distributor.

Configuration

Automated Control System

There are two separate configuration screens that you can log into from this screen.

Both logins are executed by pressing the Login found on the main page.

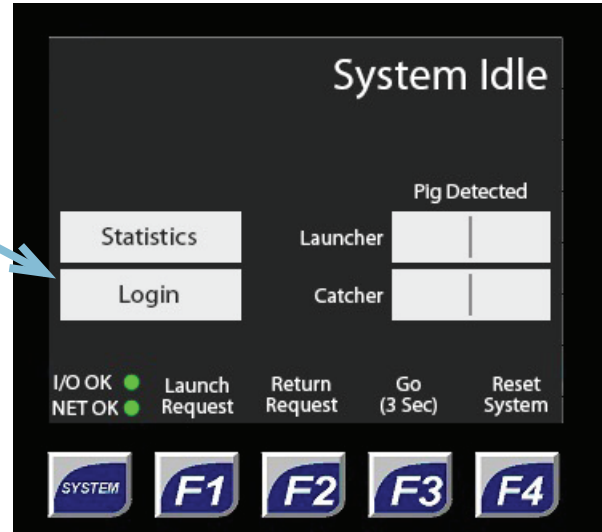

Depending on which PIN number you use, you will unlock either the CIP or Configuration screen.

When you log in with the CIP PIN, you will see the CIP button appear. The default CIP PIN is 1111.

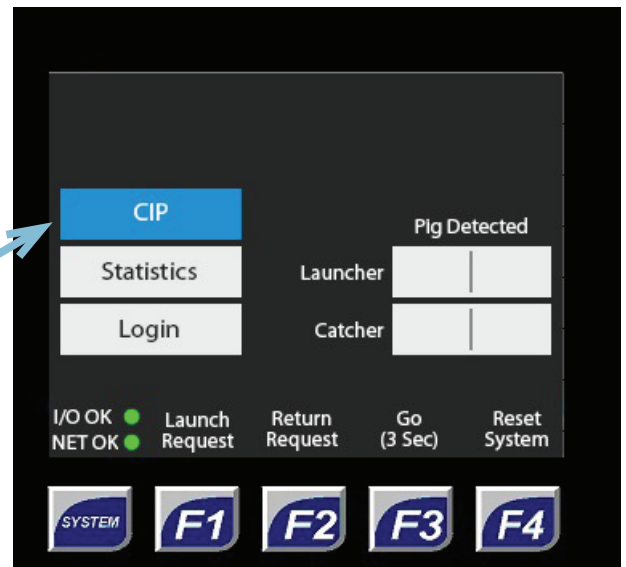

Configuration

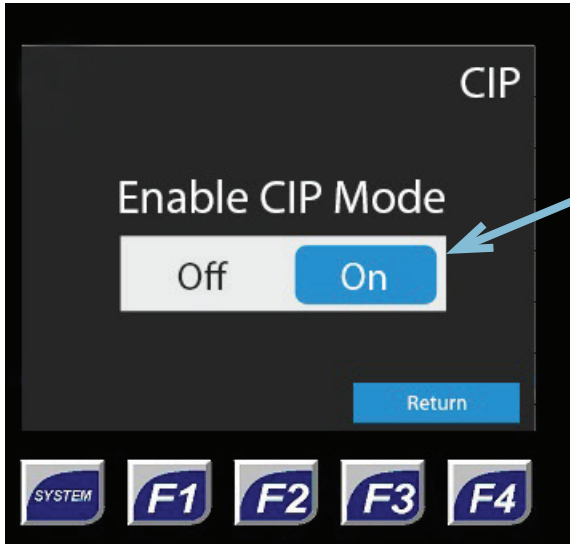

With Enable CIP Mode on, the control panel assumes control of the drain valve and air blow check valve.

These will be continuously pulsed on and off as dictated by the control panel's program.

Alternatively, you can login using your Configuration PIN which will present you with the Configuration button. The default Configuration PIN is 1234.

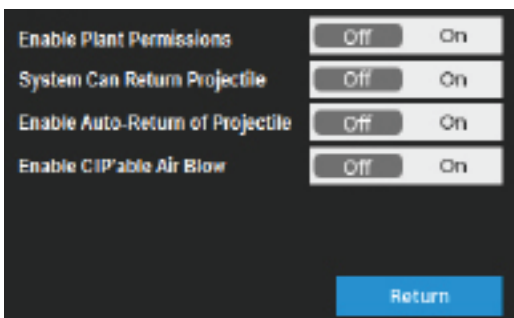
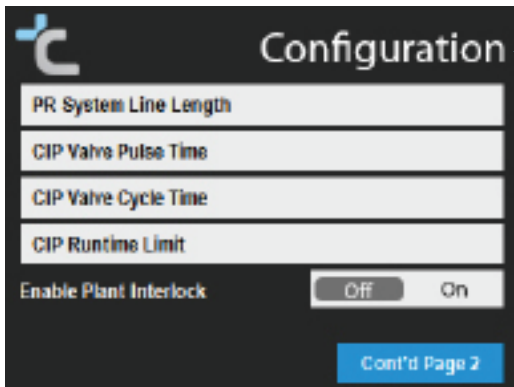
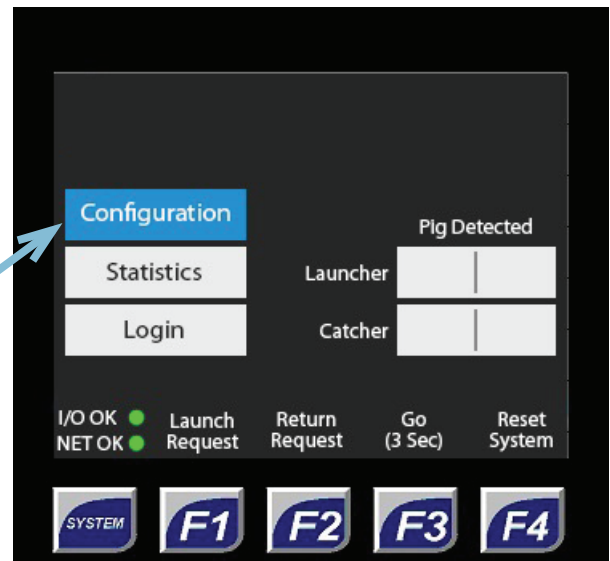

Configuration Options:

- PR System Line Length
- CIP Valve Pulse Time
- CIP Valve Cycle Time
- CIP Runtime Limit
- Enable Plant Interlock
- Enable Plant Permissions
- System Can Return Projectile
- Enable Auto-Return of Projectile
- Enable CIP'able Airblow

Configuration

Configuration Options Explained

The configuration options are factory set to match the setup and application they are designed for.

The default settings document would have been provided at the time of installation of this unit. Space to record these same results has been provided at the end of this manual.

PR System Line Length

This input is used to enter the length of tubing, in feet, of the product recovery circuit. Generally speaking, straight tube length is sufficient.

CIP Valve Pulse Time

This configures the time duration, in seconds, of the CIP pulses of the sanitary valves, which are controlled by the Product Recovery System when the system is in CIP Mode. The default time the valves are open is 2 seconds.

CIP Valve Cycle Time

This configures the time duration, in seconds, between the CIP pulses of the sanitary valves, which are controlled by the Product Recovery System when the system is in CIP Mode. The default time between pulses is 28 seconds.

CIP Runtime Limit

This sets a time limit on how long the CIP Mode is allowed to run in seconds.

Enable Plant Interlock

When on, this interlock will cause the PR System to look for a 24VDC signal from your PLC indicating it is acceptable to operate.

Configuration

Enable Plant Permissions

When on, this interlock will require a 24VDC signal from your PLC indicating the process valves are in position for a launch cycle or a return cycle.

System Can Return Projectile

When on, this tells the system whether there is a projectile returning station or not. When supplied with the proper equipment, this allows the system to return the projectile back to the launching location.

Enable Auto-Return of Projectile

When on, this tells the systems whether to automatically initiate a returning cycle after a successful launch cycle without input from an operator.

Enable CIP'able Airblow

When on, the system will include an air pulse to the airblow check valve during the CIP Mode. It should be verified that all connections to the valve are made.

Statistics Screens

From the main screen, you can select Statistics by pressing the button.

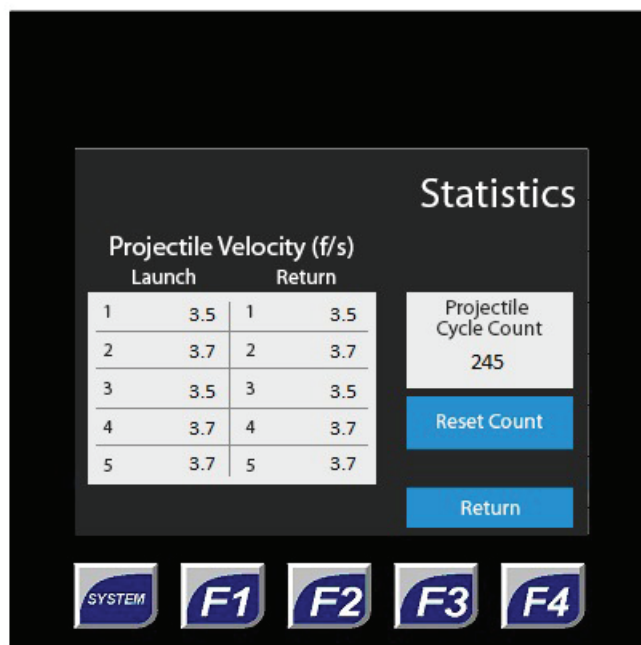
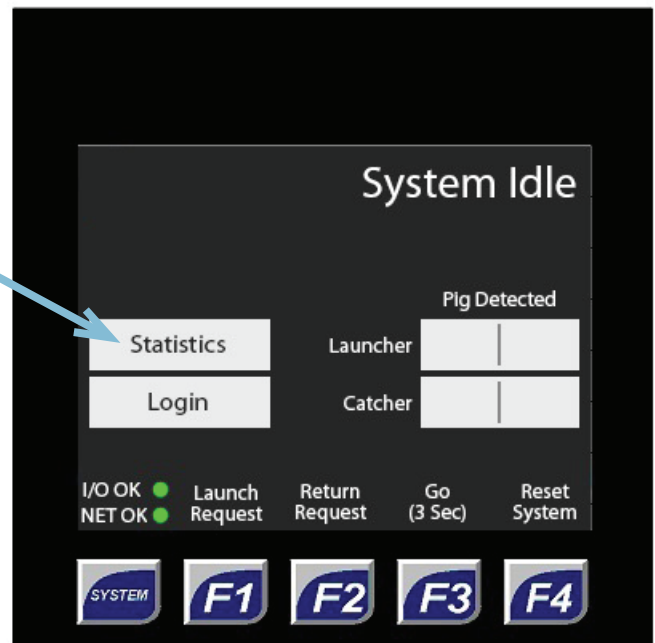

From this screen, you will be able to see the projectile velocities for the last five launch cycles.

You can also see the Projectile Cycle Count, which can be useful for planned projectile replacement

If at any point you have questions or concerns regarding your Product Recovery Auto Return Control System, please contact your TrueClean distributor.

Troubleshooting

Q. What should I do when the Product Recovery System fails to launch?

A. Try the following solutions:

1. Verify the Emergency Stop is not active.
2. Verify incoming plant airflow (SCFM) at the Product Recovery Control Panel meets minimum requirement based on your system size.
Note: Airflow in SCFM is not the same as pressure in PSIG
3. Verify the cycle complete light is NOT illuminated.
Note: If illuminated, press Reset System button.
4. Verify power to panel is on
5. If Launching from the branch, consider launching from the run
6. Verify secure air hose connections

Q. What should I do if the Pig is traveling too slow/fast?

A. Try the following solutions:

1. Verify air pressure for your application on the regulator.
Note: Pig should travel 3–5 feet per second.
2. Ensure the air hose connections are secure.
3. Consult your TrueClean distributor regarding specific application.
Note: Please have process specifications available when calling.

Q. What should I do if I see excessive wear or damage to the Pig?

A. Try the following solutions:

1. The Pig could be traveling too fast.
Note: Pig should travel 3–5 feet per second.
2. Verify incoming plant airflow (SCFM) at the Product Recovery Control Panel is appropriate, initially based on your system size.
Note: Some fine-tuning may be needed once Product Recovery System is applied on actual process line.
3. Consult your TrueClean distributor regarding specific application.
Note: Please have process specifications available when calling.

Customer Specific Configuration

CIP Login PIN (default is 1111): _____

Configuration Login PIN (default is 1234): _____

PR System Line Length: xxx ft _____

Enable CIP Mode (default is off): Off / ON

Remote Lock PR System: OFF / ON

Remote Lock Launch Valves: OFF / ON

Remote Lock Return Valves: OFF / ON

Enable CIP'able Airblow: OFF / ON

Enable Process Valves: OFF / ON

Customer Notes

Basic Install Example

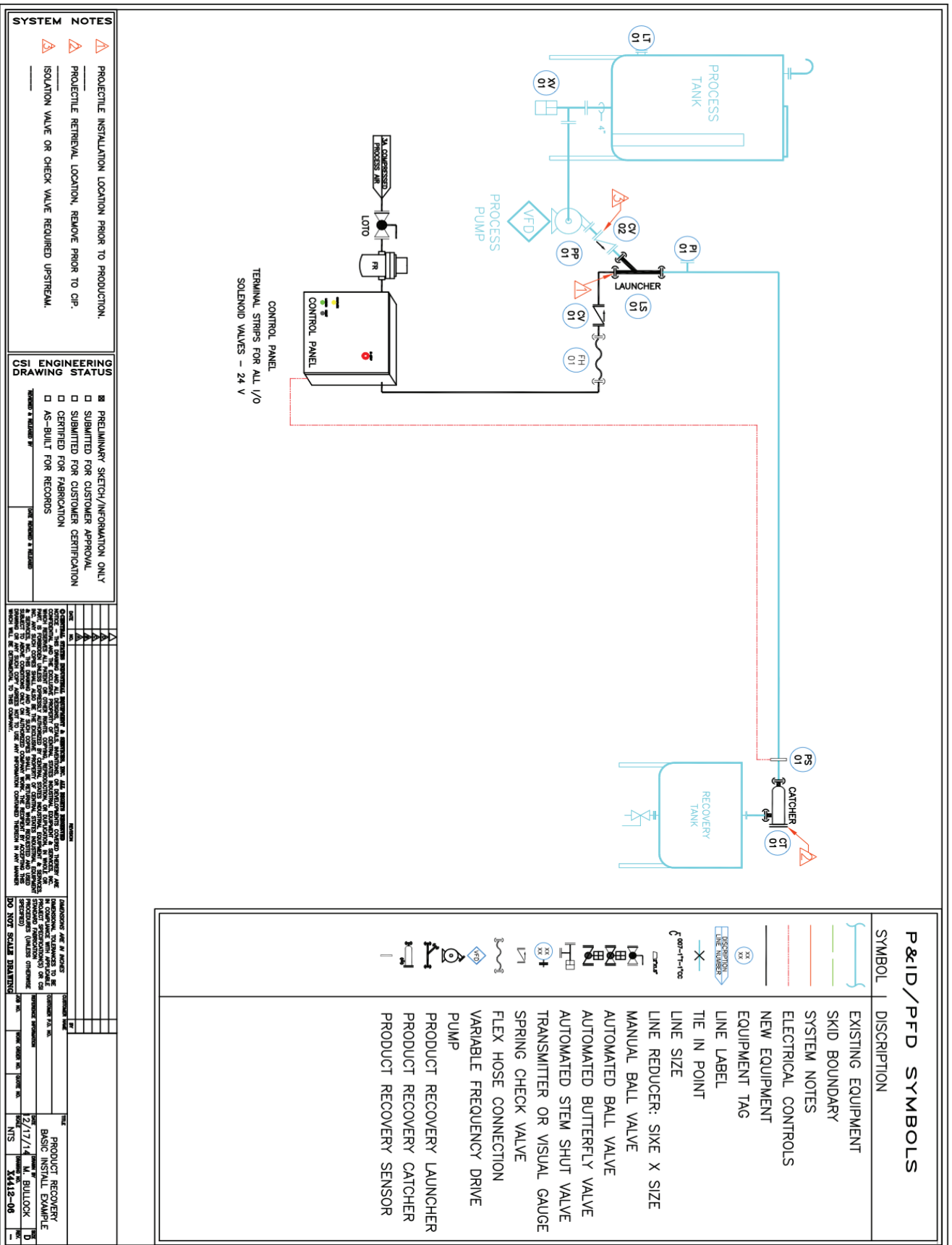

SYSTEM NOTES

- ⚠️ PROJECTILE INSTALLATION LOCATION PRIOR TO PRODUCTION.
- ⚠️ PROJECTILE RETRIEVAL LOCATION, REMOVE PRIOR TO CIP.
- ⚠️ ISOLATION VALVE OR CHECK VALVE REQUIRED UPSTREAM.

CSI ENGINEERING DRAWING STATUS

- ❑ PRELIMINARY SKETCH/INFORMATION ONLY
- ❑ SUBMITTED FOR CUSTOMER APPROVAL
- ❑ CERTIFIED FOR FABRICATION
- ❑ AS-BUILT FOR RECORDS

DESIGNED BY: _____ DATE: _____
 DRAWN BY: _____ DATE: _____
 CHECKED BY: _____ DATE: _____
 APPROVED BY: _____ DATE: _____

NO.	DATE	DESCRIPTION	BY	CHKD.	APP'D.
1	2/17/14	PRODUCT RECOVERY BASIC INSTALL EXAMPLE	M. BULLOCK		
2					
3					
4					
5					

DO NOT SCALE DRAWING

SYMBOL	DESCRIPTION
	EXISTING EQUIPMENT
	SKID BOUNDARY
	SYSTEM NOTES
	ELECTRICAL CONTROLS
	NEW EQUIPMENT
	EQUIPMENT TAG
	LINE LABEL
	TIE IN POINT
	LINE SIZE
	LINE REDUCER: SIX X SIZE
	MANUAL BALL VALVE
	AUTOMATED BALL VALVE
	AUTOMATED BUTTERFLY VALVE
	AUTOMATED STEM SHUT VALVE
	TRANSMITTER OR VISUAL GAUGE
	SPRING CHECK VALVE
	FLEX HOSE CONNECTION
	VARIABLE FREQUENCY DRIVE PUMP
	PRODUCT RECOVERY LAUNCHER
	PRODUCT RECOVERY CATCHER
	PRODUCT RECOVERY SENSOR

Returning Install Example

