

P.L. : 1001-P01

Effective
Replaces

March 2018
May 2016

PARTS LIST
PUMPS
MICRO C 125 - 250 - 500 - 800

Keep this parts lists with Installation, Operation and Maintenance Instructions.

To order the required spare parts, indicate the desired Reference(s).

- ◆ To order the required spare parts, indicate the desired Reference(s).

MICRO C 125 - 250 - 500 - 800

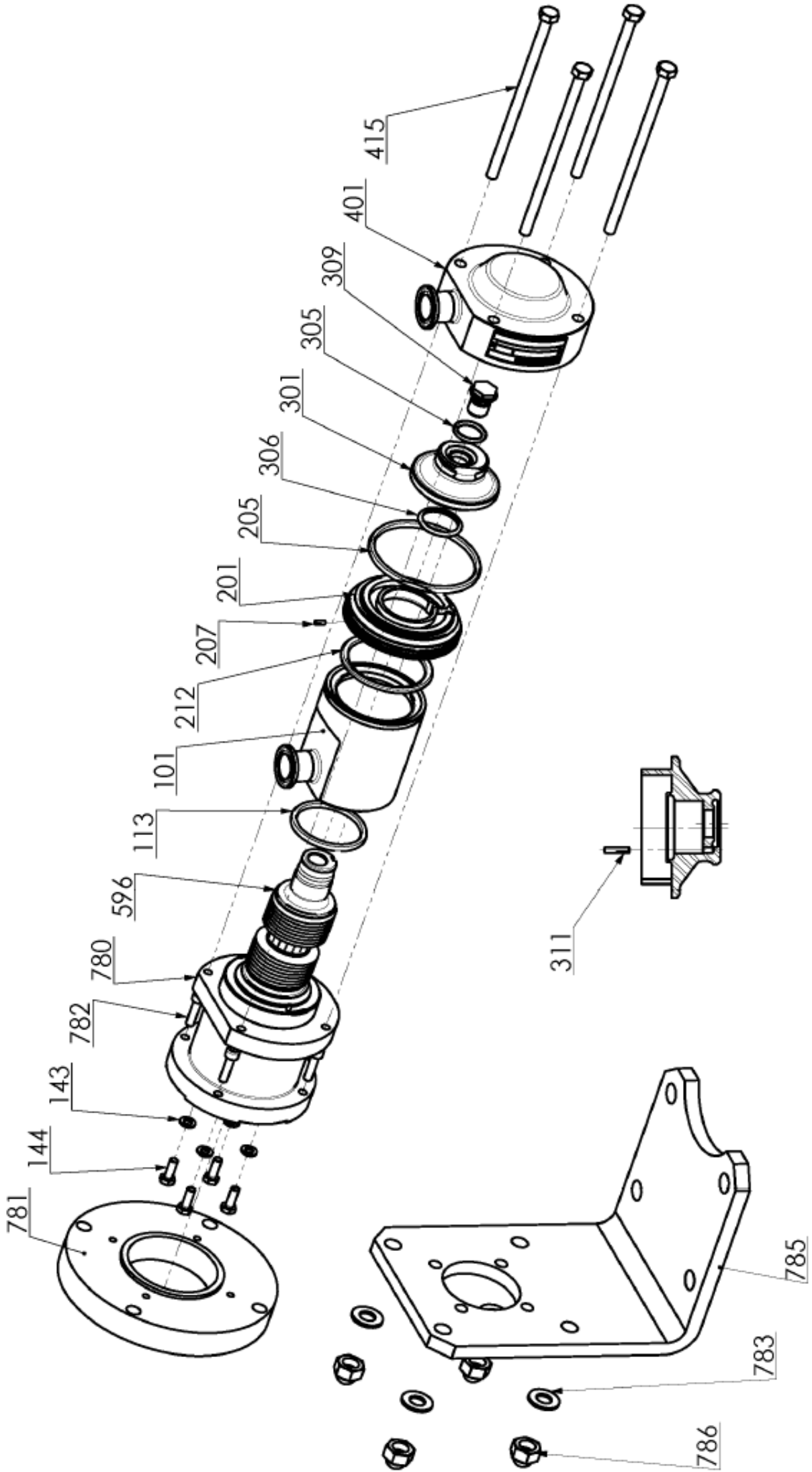

MICRO C 500

* 1, 2, 4... : Quantity in equipment - (1), (2), (4)... : Quantity in kit

Item	Available	Description	Qty*	Ref.	Maintenance kit	Wear part
101	◆	INLET MANIFOLD CONNECTION 1_2" BSP	1	313830.00		
101	◆	INLET MANIFOLD CONNECTION 1_2" NPT	1	313831.00		
101	◆	INLET MANIFOLD CONNECTION CLAMP ASME BPE	1	316485.00		
101	◆	INLET MANIFOLD CONNECTION CLAMP DIN 32676	1	313829.00		
101	◆	INLET MANIFOLD CONNECTION CL ISO25	1	314046.00		
101	◆	INLET MANIFOLD CONNECTION DIN20	1	313828.00		
101	◆	INLET MANIFOLD CONNECTION SMS25	1	313918.00		
200	◆	SET CYLINDER_PISTON MC500	1	313838.02	■	
201		CYLINDER	(1)			●
207		PIN	(1)			
301		PISTON	(1)			●
309	◆	PISTON SCREW	1	224792		
311		PIN	(1)			
206	◆	SET OF FEP-FKM 'O' RING SEALS	1	313840.01	■	
206	◆	SET OF FKM 'O' RING SEALS	1	313839.02	■	
113		SEAL	(1)			●
205		SEAL RING	(1)			●
212		SEAL	(1)			●
305		SEAL	(1)			●
306		SEAL	(1)			●
309	◆	PISTON SCREW	1	224792		
401	◆	FRONT COVER PLATE 1_2" BSP	1	313834.00		
401	◆	FRONT COVER PLATE 1_2" NPT	1	313835.00		
401	◆	FRONT COVER PLATE CLAMP ASME BPE	1	316486.00		
401	◆	FRONT COVER PLATE CLAMP DIN 32676	1	313833.00		
401	◆	FRONT COVER PLATE CLAMP ISO25	1	314047.00		
401	◆	FRONT COVER PLATE DIN20	1	313832.00		
401	◆	FRONT COVER PLATE SMS25	1	313919.00		
415	◆	SCREW	4	224186	■	
596	◆	COMPLETE TRANSMISSION	1	313817.03	■	●
1024	◆	TRANSMISSION ADAPTATION KIT (for pump delivered before the 31.08.2008)	1	315143.00		
309		PISTON SCREW		(1)		
780		TRUNK		(1)		