



800.654.5635 • www.csdesigns.com

# Proven Performance and Reliability

## SCPP 2 Circumferential Piston Pump

### Application

The SCPP range of positive displacement pumps have been designed for use on a wide range of applications within: Dairy, Food, Beverage, Pharma and Personal Care markets. The highly efficient design is particularly suited to applications that are low in viscosity with medium to high discharge pressures.

### Clean-In-Place

Optional internal flush ports for increased exposure of O-rings and rotor hubs to the flushing liquid. A flat body profile is also available which allows drainability when pump ports are in the vertical position

### Standard Design

**Pump Gearbox** The SCPP pump with its circumferential piston pump design concept has a cast iron gearbox which provides maximum shaft rigidity. Gear box is powder-coated. 17-4 PH High-Strength steel shafts on all sizes. Four-way mounting allows horizontal or vertical porting and provides mounting flexibility.

**Pumphead Construction** The SCPP in standard specification has pump casing in AISI 316 stainless steel with an internal surface finish of Ra 32/Ra 0.8 complying to 3A standards. Rotors are made of special non-galling alloy and are available as standard with twin-wing form or optionally with single wing for handling large solids. Seal options include single mechanical seal or double mechanical seal with flush.

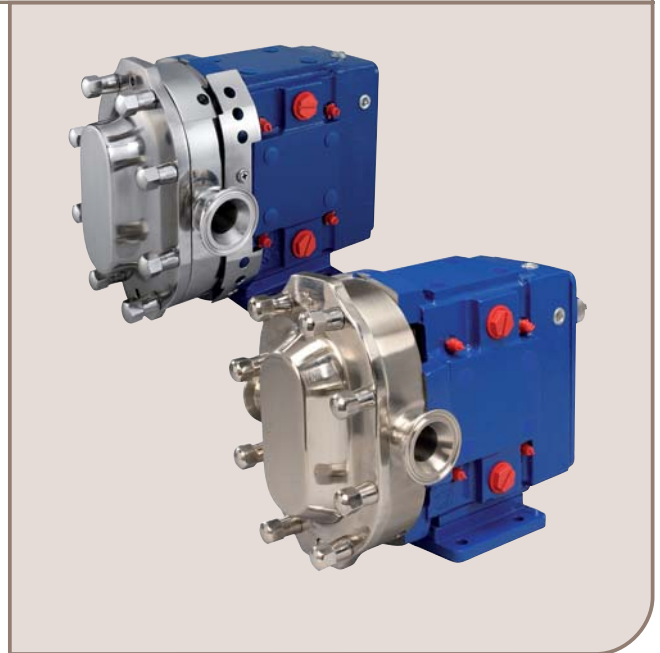

### Pump Performance

SCPP 2 Model	Nominal Capacity		Displacement per Revolution		Maximum Pressure		Temperature Range		Standard Ports		Optional Ports		Maximum Speed (RPM)
	US		Litre	US Gal.	Bar	PSI	Deg. C	Deg. F	mm	in.	mm	in.	
	M <sup>3</sup> /hr	GPM											
006	1.8	8	0.030	0.008	21	300	-40° to 150°	-40° to 300°	25.4	1.0	38.0	1.5	1000
015	2.5	11	0.052	0.014	17	250	-40° to 150°	-40° to 300°	38.0	1.5	-	-	800
018	4.5	20	0.108	0.029	14	200	-40° to 150°	-40° to 300°	38.0	1.5	51.0	2.0	700
030	8.2	36	0.227	0.060	17	250	-40° to 150°	-40° to 300°	38.0	1.5	51.0	2.0	600
045	13.2	58	0.366	0.096	31	450	-40° to 150°	-40° to 300°	51.0	2.0	-	-	600
060	20.4	90	0.568	0.150	21	300	-40° to 150°	-40° to 300°	64.0	2.5	76.0	3.0	600
130	34.1	150	0.946	0.250	14	200	-40° to 150°	-40° to 300°	76.0	3.0	-	-	600
180	52.2	230	1.450	0.383	31	450	-40° to 150°	-40° to 300°	76.0	3.0	-	-	600
210	68.1	300	1.890	0.500	34	500	-40° to 150°	-40° to 300°	102.0	4.0	-	-	600
220	70.4	310	1.950	0.516	21	300	-40° to 150°	-40° to 300°	102.0	4.0	-	-	600

SCPP 2 Rectangular Flange Model	Nominal Capacity		Displacement per Revolution		Maximum Pressure		Temperature Range		Inlet (W x L)		Outlet		Maximum Speed (RPM)
	US		Litre	Gal.	Bar	PSI	Deg. C	Deg. F	mm	in.	mm	in.	
	M <sup>3</sup> /hr	GPM											
024	2.5	11.6	0.11	0.03	14	200	-40° to 150°	-40° to 300°	33.27 x 125.22	1.31 x 4.63	38.1	1.5	400
034	5.4	24.0	0.23	0.06	14	200	-40° to 150°	-40° to 300°	44.50 x 171.45	1.75 x 6.75	38.1	1.5	400
064	13.6	60.0	0.57	0.15	14	200	-40° to 150°	-40° to 300°	56.90 x 224.03	2.24 x 8.82	57.15	2.5	400
134	22.7	100.0	0.95	0.25	14	200	-40° to 150°	-40° to 300°	75.44 x 234.95	2.97 x 9.25	76.2	3.0	400
224	45.4	200.0	1.95	0.52	14	200	-40° to 150°	-40° to 300°	98.30 x 279.40	3.87 x 11.00	101.6	4.0	400

Hot clearances required for high temperature operation.

## Materials of Construction

Pump gearbox – high quality grey cast iron. Pumphead – product wetted components in 316L and rotors in special non-galling material. Product wetted elastomers EPDM, NBR, FPM all FDA conforming. Also PTFE for chemical applications.

## Shaft Sealing Options

...for different liquids and conditions of service

### Single Mechanical Seals

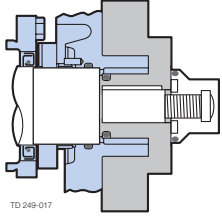

- Standard Seal Faces: SiC/SiC
- Standard O-rings and Cover Seals: Buna
- Optional Faces: Carbon, Ceramic
- Optional O-rings and Cover Seals: FPM, EPDM, Silicone

### Double Mechanical Seals with Flush

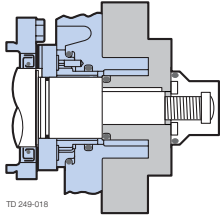

- Standard Seal Faces: SiC/SiC
- Standard O-rings and Cover Seals: Buna
- Optional Faces: Carbon, Ceramic
- Optional O-rings and Cover Seals: FPM, EPDM, Silicone

### Twin Wing Rotors Standard.

Provides minimum pulsation.

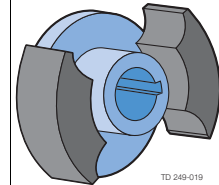

### Single Wing Rotors Optional.

Provides reduced shear on shear sensitive fluids or large solids such as fruit pieces, nut kernels, cheese curds or meats.

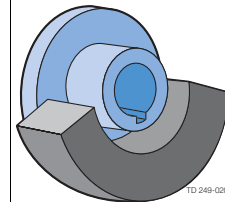

## Remanufacturing Value

We offer unrivaled value by remanufacturing worn Alfa Laval or competitor circumferential piston pumps to like-new condition, providing you with increased efficiency and reduced slip for enhanced productivity. Alfa Laval will replace all parts except the cover, pump case, gear case in their remanufacturing process, and provide you a one-year warranty on the work. Machined in increments as required by wear, the pump case and cover are outfitted with corresponding oversized rotors. The SCPP 1 can be remanufactured up to 4 times, and the SCPP 2 up to three times for unmatched savings. Alfa Laval remanufacture and complete factory tests to ensure your pumps perform from day one and beyond. Best of all, having your pumps remanufactured by Alfa Laval gets you all of our improved features such as:

- One-piece shafts
- Helical timing gears for higher load carrying and quieter operation
- Stainless steel bearing retainers for increased corrosion resistance



## Alfa Laval Positive Displacement Circumferential Piston Pumping Principle



Alfa Laval rotor wings (pistons) rotate around the circumference of the channel in the pump casing. This continuously generates a partial vacuum at the suction port as the rotors unmesh, causing fluid to enter the pump. The fluid is transported around the channel by the rotor wings, and is displaced as the rotor wings converge, generating pressure at the discharge port. Direction of flow is reversible.

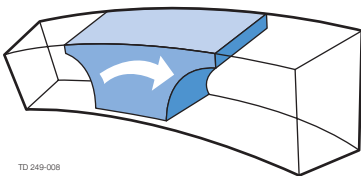

TD 249-008

The deep channels in which the rotors travel provide large voids to minimize shear and bruising of solids.

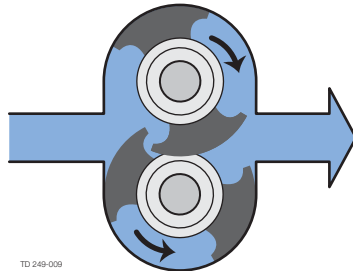

TD 249-009

The rotors are made of non-galling alloy, allowing extremely tight clearances between rotating and stationary surfaces, which ensures high efficiency and metering accuracy, even on thin liquids.

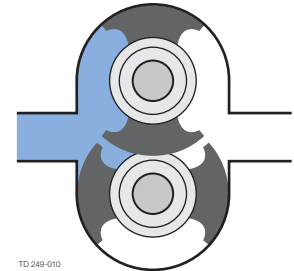

TD 249-010

The hub of each non-galling rotor rotates in a recess in the pump head to minimize deflection even at high discharge pressures.

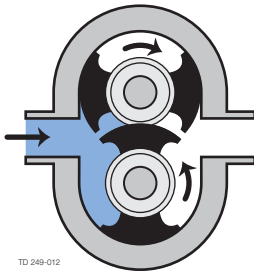

TD 249-012

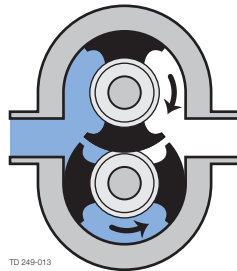

TD 249-013

Suction

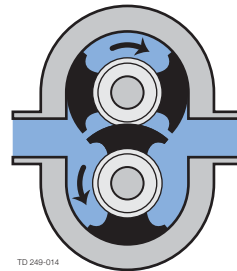

TD 249-014

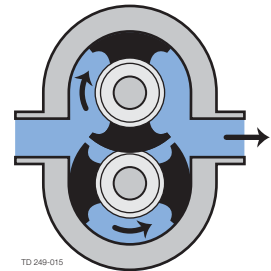

TD 249-015

Discharge



800.654.5635 • [www.csdesigns.com](http://www.csdesigns.com)

## Dimensions

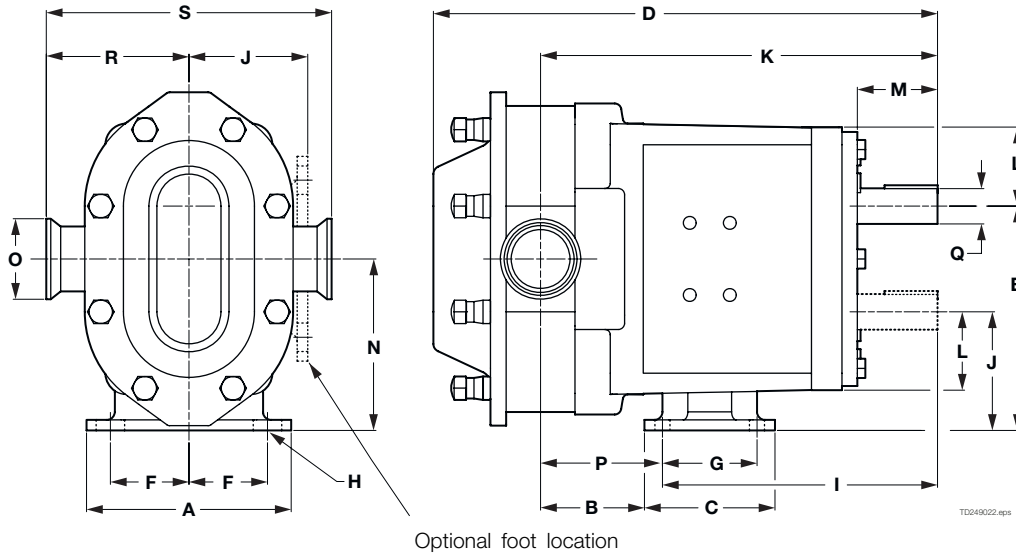

(mm)

Model	A	B	C	D	E	F	G	H	I	J	K	L	M	N	O	P	Q Ø	R	S	Weight
006	121	50	95	297	140	49	59	9.5 x 8 (slot)	173	74	244	54	51	107	38	71	22.23	89	177	24 kg
015	121	50	95	297	140	49	59	9.5 x 8 (slot)	173	74	244	54	51	107	38	71	22.23	89	177	24 kg
018	121	55	95	314	140	49	59	9.5 x 8 (slot)	173	74	250	54	51	107	38	77	22.23	89	177	24 kg
030	159	71	108	368	174	59	65	11 x 11 (slot)	197	90	295	67	59	132	38	98	31.75	108	216	45 kg
045	210	98	149	472	243	89	105	14 x 13 (slot)	257	129	377	89	57	186	51	120	41.28	136	273	132 kg
060	210	105	149	486	243	89	105	14 x 13 (slot)	257	129	385	89	57	186	63	127	41.28	136	273	132 kg
130	210	121	149	512	243	89	105	14 x 13 (slot)	257	129	401	89	57	186	76	144	41.28	136	273	142 kg
180	216	88	229	591	314	95	184	14 x 13 (slot)	357	162	450	114	70	238	76	107	50.8	166	332	238 kg
210	305	88	295	688	353	133	203	16 Ø	420	175	539	129	103	264	102	119	60.33	187	374	395 kg.
220	216	94	229	610	314	95	184	14 x 5 (slot)	357	162	470	114	70	238	102	113	50.80	168	337	252 kg

(in)

Model	A	B	C	D	E	F	G	H	I	J	K	L	M	N	O	P	Q Ø	R	S	Weight
006	4.75	1.95	3.75	11.71	5.50	1.94	2.31	0.375 x 0.31 (slot)	6.82	2.93	9.61	2.12	2.00	4.21	1.50	2.79	0.875	3.49	6.97	53 lb.
015	4.75	1.95	3.75	11.71	5.50	1.94	2.31	0.375 x 0.31 (slot)	6.82	2.93	9.61	2.12	2.00	4.21	1.50	2.79	0.875	3.49	6.97	53 lb.
018	4.75	2.18	3.75	12.37	5.50	1.94	2.31	0.375 x 0.31 (slot)	6.82	2.93	9.84	2.12	2.00	4.21	1.50	3.02	0.875	3.49	6.97	53 lb.
030	6.25	2.78	4.25	14.49	6.86	2.31	2.56	0.438 x 0.44 (slot)	7.77	3.56	11.61	2.62	2.32	5.21	1.50	3.84	1.250	4.25	8.50	99 lb.
045	8.25	3.86	5.87	18.59	9.56	3.50	4.12	0.56 x 0.50 (slot)	10.13	5.06	14.86	3.50	2.25	7.31	2.00	4.73	1.625	5.37	10.75	290 lb.
060	8.25	4.14	5.87	19.14	9.56	3.50	4.12	0.56 x 0.50 (slot)	10.13	5.06	15.14	3.50	2.25	7.31	2.50	5.01	1.625	5.37	10.75	290 lb.
130	8.25	4.78	5.87	20.15	9.56	3.50	4.12	0.56 x 0.50 (slot)	10.12	5.06	15.77	3.50	2.25	7.31	3.00	5.65	1.625	5.37	10.75	312 lb.
180	8.50	3.45	9.00	23.26	12.38	3.75	7.25	0.56 x 0.50 (slot)	14.05	6.38	17.75	4.50	2.75	9.38	3.00	4.20	2.000	6.53	13.06	528 lb.
210	12.00	3.45	11.63	27.08	13.88	5.25	8.00	0.66 Ø	16.54	6.88	21.24	5.06	4.06	10.38	4.00	4.70	2.375	7.37	14.73	870 lb.
220	8.50	3.69	9.00	24.00	12.38	3.75	7.25	0.56 x 0.19 (slot)	14.05	6.38	18.49	4.50	2.75	9.38	4.00	4.44	2.000	6.63	13.25	555 lb.

ESE01677EN 1004

The information contained herein is correct at the time of issue, but may be subject to change without prior notice.



**800.654.5635**  
**www.csidesigns.com**