



Simply Unique

Unique 7000 Series - Reverse Acting

General Information

The Unique 7000 Series is an innovative new generation of Tri-Clover® single seat valves that are designed to meet the highest process demands of hygiene and safety. They're built on a well-proven, platform from an installed base of more than one million valves.

Application

The reverse acting version of the Unique 7000 is a sanitary air-operated seat valve with a flexible design. It can be configured as a shut-off valve with two or four ports or as a change-over valve with three to six ports. It's ideal applications include the dairy, beverage, brewery, food, pharmaceutical, biotechnology and personal care industries.

Working principle

The valve is remote-controlled by means of compressed air. It has few and simple moveable parts which results in a very reliable valve with low maintenance cost.

Standard design

The Unique 7000 valve is designed to deliver years of reliability and performance you've come to expect with all Tri-Clover products. It's flexible design consists of two to three bodies that are clamped together. The TR2 seat ring with enhanced CIP capabilities and hygiene comes standard with all Unique 7000 series valves. For added confidence, the valve can be supplied with a controlled compression elastomer seal ring. The actuator comes with a five year warranty. The Unique 7000 valve sizes range from 1" to 4".

Other valves in the same basic design

- Long stroke valve.
- Manually operated valve.



Unique 7000 Series - Reverse Acting change-over valve and shut-off valve

Unique 7000 Series - Reverse Acting Pressure Drop Diagrams

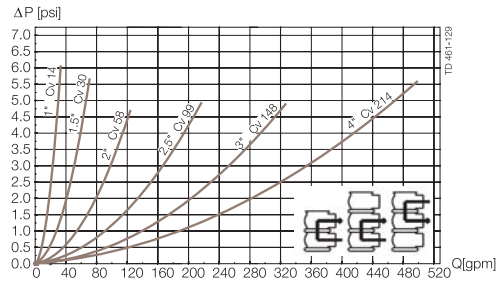
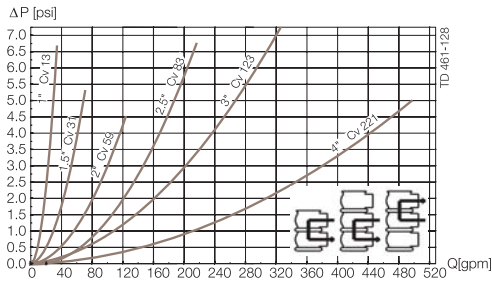

Note!

For the diagrams the following applies:

Medium: Water (68° F/20° C)

Measurement: In accordance with VDI2173

Pressure data for Unique 7000 Series - Reverse Acting

Table 1 - Shut-off and change-over valves. Max. pressure in psi without leakage at the valve seat

Actuator/valve body combination and direction of pressure	Air pressure [psi]	Plug position	Valve size						
			1"	1½"	2"	2½"	3"	4"	
Change-over valve									
TD 462-026		NC	145.0	118.9	121.8	65.3	98.6	63.8	
TD 462-029	87.6	NC	145.0	110.2	139.2	81.2	104.4	69.6	
TD 462-028		NO	145.0	91.4	104.4	60.9	92.8	60.9	
TD 462-027	87.6	NO	145.0	145.0	145.0	88.4	111.7	72.5	
TD 462-018	87.6	A/A	145.0	145.0	145.0	145.0	130.5	84.1	
TD 462-019	87.6	A/A	145.0	145.0	145.0	145.0	123.3	81.2	

Table 2: Shut-off and change-over valves. Max. pressure in psi against which the valve can open.

Actuator/valve body combination and direction of pressure	Air pressure [psi]	Plug position	Valve size						
			1"	1½"	2"	2½"	3"	4"	
Change-over valve									
TD 462-022		NO	145.0	140.6	145.0	98.6	66.7	45.0	
TD 462-021	87.6	NC	145.0	145.0	145.0	120.4	143.6	95.7	
TD 462-023		NC	145.0	145.0	145.0	107.3	71.1	46.4	
TD 462-020	87.6	NO	145.0	145.0	145.0	130.5	145.0	100.1	

A = Air
AC = Air closes
AO = Air opens

P = Product pressure
SC = Spring closes
SO = Spring opens

Dimensions

	Nominal size					
	1"	1½"	2"	2½"	3"	4"
A ₁	13.3	13.96	16.21	17.19	19.05	21.00
A ₂	13.77	14.79	17.23	18.22	20.3	22.22
A ₃	15.18	16.5	19.27	20.75	23.10	26.02
A ₄	15.61	17.15	20.14	21.61	24.17	27.08
C	1.88	2.39	2.91	3.40	3.89	4.87
OD	0.98	1.50	2.01	2.50	3.00	4.00
ID	0.86	1.37	1.88	2.37	2.87	3.84
t	0.06	0.06	0.06	0.06	0.06	0.08
E	1.97	1.95	2.44	3.23	3.43	4.72
F ₁	0.47	0.83	1.02	1.02	1.22	1.22
F ₂	0.43	0.63	0.87	0.87	1.06	1.06
G	0.94	1.95	2.44	3.23	3.43	4.72
H	3.35	3.35	4.52	4.52	6.07	6.07
M (Tri-Clamp)	0.50	0.50	0.50	0.50	0.50	0.63
Weight (lb)						
Shut-off valve	10.14	10.58	17.20	9.5	34.84	43.65
Change-over valve	12.13	12.79	20.28	20.94	41.01	54.01

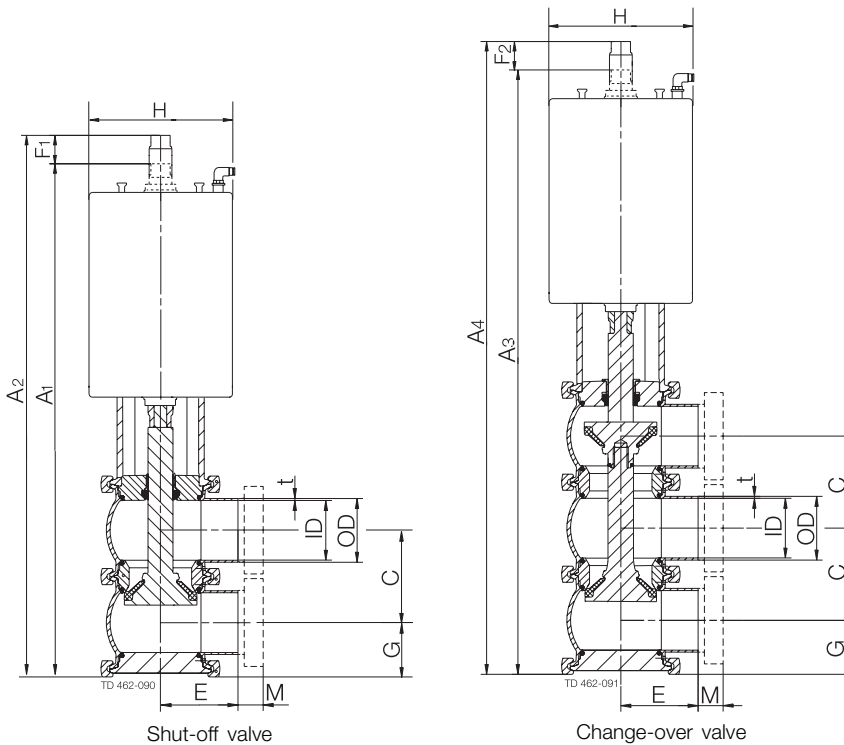

Caution. opening/closing time:

Opening/closing time will be effected by the following:

- The air supply (air pressure).
- The length and dimensions of the air hoses.
- Number of valves connected to the same air hose.
- Use of single solenoid valve for serial connected air actuator functions.
- Product pressure.

Air Connections Compressed air:

R 1/8" (BSP). internal thread.

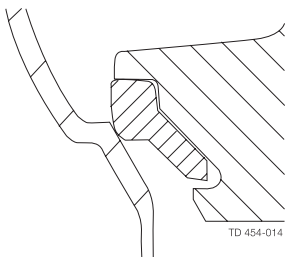

PTFE plug seal (TR2)

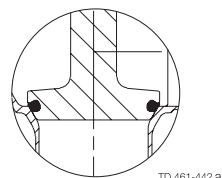

Replaceable elastomer plug seal

Technical data

Max. product pressure:145 psi (1000 kPa (10 bar)).
 Min. product pressure:Full vacuum.
 Temperature range:-50°F to +284°F (EPDM).
 Air pressure:72.5 to 101.5 psi (500 to 700 kPa (5 - 7 bar)).

Valve body combinations

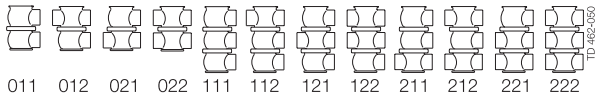

Actuator function

- Pneumatic downward movement, spring return.
- Pneumatic upward movement, spring return.
- Pneumatic upward and downward movement (A/A).

Size	Air Consumption (in ³ free air) for one stroke		
	1"-1½"	2"-2½"	3"-4"
NO and NC	0.96 x air pressure [psi]	2.17 x air pressure [psi]	5.51 x air pressure [psi]
A/A	1.94 x air pressure [psi]	4.82 x air pressure [psi]	11.15 x air pressure [psi]

Materials

Product wetted steel parts:AISI 316L (internal Ra < 32 μ inch)
 Other steel parts:AISI 304
 Plug seal:PTFE (TR2) (standard)
 Optional elastomer plug seal:EPDM, HNBR or FPM
 Other product wetted seals:EPDM (standard)
 Optional product wetted seals:HNBR or FPM
 Other seals:NBR

Options

- a. Weld ends or connection types other than Tri-Clamp.
- b. Control and Indication: IndiTop, ThinkTop, ThinkTop Basic and GreenTop.
- c. Product wetted seals in HNBR or FPM.
- d. Replaceable elastomer plug seals.
- e. High pressure actuator.
- f. Maintainable actuator.
- g. External surface finish blasted.

Ordering

Please state the following when ordering:

- Size.
- Connections
- Valve body combination.
- Actuator Function: NC, NO or A/A.
- Options.

Note!

For further details, see instruction ESE00213.

Description Code Unique 7000

Examples:

7610-012M1H40-1SSS-TY-S041 (All Ports Tri-Clamp)

7610-012SNNNNWMM1H40-1SSS-TY-S041
(Combination Ports Weld & Tri-Clamp)

Valve function			Body				Actuation				Stem/elastomer		Misc.	
1	2	3	4	5	6	7	8	9	10	11	12	13	14	
7610	012	S	M	1	H40	1	S	S	S	T	Y	S	04	
			S	N	N	N	N	W	M	M				

1 Model	Code
-- Unique 7000	7610
-- Unique 7000 Aseptic	8610
-- Unique 7000 Tangential Outlet (Horizontal Mounting)	7620
-- Unique 7000 Tank Outlet (Vertical Mounting)	7630
-- Unique 7000 Regulating	7710
2 Body style	Code
-- Shut-off (2 port)	200
-- Shut-off (3 port)	300
-- Shut-off Tangential Right (2 port)	208
-- Shut-off Tangential Left (2 port)	207
-- Shut-off Tangential Cross (3 port)	309
-- Change Over (3 port)	210
-- Change Over (4 port)	220
-- Change Over (4 port)	310
-- Change Over (5 port)	320
-- Shut-off RA (Reverse Acting) (2 port)	011
-- Shut-off RA (3 port)	021
-- Shut-off RA (3 port)	012
-- Shut-off RA (4 port)	022
-- Change Over RA (3 port)	111
-- Change Over RA (4 port)	211
-- Change Over RA (4 port)	121
-- Change Over RA (4 port)	112
-- Change Over RA (5 port)	212
-- Change Over RA (6 port)	222
-- Y-body	900
3 Build in dimension	Code
-- Standard	S
-- 700 Series Build Dimensions (Center-Face; shut-off only)	C
4 Connection Ports - all identical	Code
-- Weld ends - all ports	W
-- Tri-Clamp - all ports	M
-- Threaded Bevel Seat - all ports	T
Connection Ports - mixed	Code
-- Mixed connection types	S
-- Weld end	W
-- Tri-Clamp	M
-- Iso Clamp	I
-- Union SMS	S
-- Union DIN	C
-- Din Clamp	D
-- Threaded Bevel Seat	T
-- No port	N
5 Surface Finish	Code
-- 3A (OD = Dust blast; ID = 32Ra)	1
-- 3A Bright (OD = Bright; ID = 32Ra)	2
-- PC (3A) (OD = Dust blast; ID = 20Ra)	3
-- PL (3A) (OD = Bright; ID = 20Ra)	4
-- PP (3A) (OD = Bright; ID = 15Ra)	5
-- PM (3A) (OD = Bright; ID = 15Ra w/EP)	6
6 Size (Port)	Code
-- 1/4-inch	H10
-- 1/2-inch	H15
-- 2/4-inch	H20
-- 2 1/2-inch	H25
-- 3-inch	H30
-- 4-inch	H40
7 Actuation Mode	Code
-- Norm. Open/Spring to open	1
-- Norm. Open/Spring to open (RA)	2
-- Norm. Closed/Spring to close	2
-- Norm. Closed/Spring to close (RA)	1
-- Air to air	3
-- Two-step/Three Position	4
-- Manual	5
8 Actuator Stroke	Code
-- Standard	S
-- Long Stroke	L
9 Actuator Type	Code
-- Maintainable	R
-- Semi maintainable	S
10 Holding Pressure Capability	Code
-- Standard	S
-- High pressure	H
11 Stem Type	Code
-- Elastomer Plug Seal	S
-- TR2/PTFE Plug Seal	T
12 Wetted Seal Materials	Code
-- EPDM	E
-- HNBR	U
-- FPM (Fluoroelastomer)	Y
13 Assembled Valve	Code
-- Assembled valve	S
14 Top Unit Type	Code
IndiTop digital 0 solenoid	IT
ThinkTop digital 1 solenoid	TB
ThinkTop digital 2 solenoid	TC
ThinkTop ASI 0 solenoid	TE
ThinkTop ASI 1 solenoid	TF
ThinkTop ASI 2 solenoid	TG
ThinkTop DeviceNet 0 solenoid	TJ
ThinkTop DeviceNet 1 solenoid	TJ
ThinkTop DeviceNet 2 solenoid	TK
ThinkTop Digital 110V 0 solenoid	TM
ThinkTop Digital 110V 1 solenoid	TN
ThinkTop Digital 110V 2 solenoid	TO
GreenTop 2 Mech Switches 0 Solenoid	04
GreenTop 2 Prox Switches 0 Solenoid	12
GreenTop 24 VDC 2 Mech Switches 1 Solenoid	18
GreenTop 110 VAC 2 Mech Switches 0 Solenoid	20
GreenTop 24 VDC 2 Prox Switches 1 Solenoid	34
GreenTop 110 VAC 2 Prox Switches 1 Solenoid	36

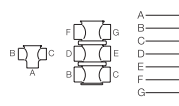
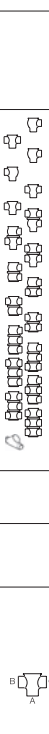

ESE00179ENUS 0608

The information contained herein is correct at the time of issue,
but may be subject to change without prior notice.

How to contact Alfa Laval

Contact details for all countries
are continually updated on our website.
Please visit www.alfalaval.com to
access the information direct.



800.654.5635
www.csidesigns.com

 Authorized to carry
the 3A symbol